

MeanWell Powering Smart Choices

Instruction Manual

Smart Dimmer Module

MMC1252

ZigBee

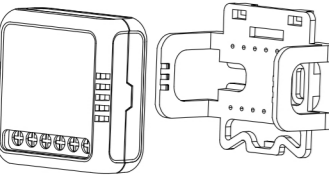

English

WORKS WITH alexa

WORKS WITH Google Assistant

Global international operation Whenever & Wherever you are, All-in-one Mobile App

Schedule timer

Voice control work with Google Home

Voice control work with Amazon Alexa

Device Sharing

Anywhere

Inhouse local operation

APP

Router

Voice control

Push wall switch (Reset switch)

Escanee el código QR para obtener el manual en español, el video de instalación y la introducción de la función

Veuillez scanner le code QR pour obtenir le manuel en français, la vidéo d'installation et l'introduction des fonctions

Отсканируйте QR-код, чтобы получить руководство на русском языке, видео по установке и описание функций

Scansionare il codice QR per ottenere il manuale in italiano, il video di installazione e la guida alle funzionalità. Video di installazione e funzionalità

Leia o código QR para obter o manual em português, o vídeo de instalação e a introdução das funções

Zeskanuj kod QR, aby uzyskać instrukcje, imy instalacyjne i funkcje

من فضلك قم بمسح رمز الاستجابة QR-Code للحصول على دليل المستخدم باللغة العربية ومفيد للتثبيت ووصف الوظائف



Global international operation Whenever & Wherever you are, All-in-one Mobile App

Schedule timer

Voice control work with Google Home

Voice control work with Amazon Alexa

Device Sharing

Anywhere

Inhouse local operation

APP

Router

Voice control

Push wall switch (Reset switch)

Step 1

Remove the old switch

Turn off the circuit breaker and use the electrical tester to test the power.

Ensure the circuit breaker is off before wiring.

Attention: Please disconnect the power supply before installing or removing the device for avoiding irreversible damage on the device from the electric current or some unpredictable problems such as lamp flashing.

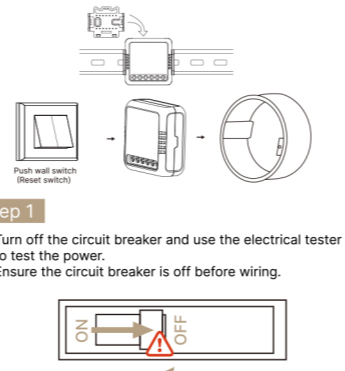

Step 2

Remove the old switch

Turn off the circuit breaker and use the electrical tester to test the power.

Ensure the circuit breaker is off before wiring.

Attention: Please disconnect the power supply before installing or removing the device for avoiding irreversible damage on the device from the electric current or some unpredictable problems such as lamp flashing.

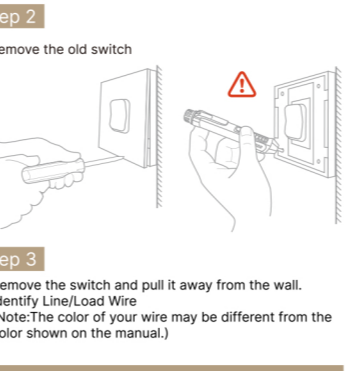

Step 3

Remove the switch and pull it away from the wall. Identify Line/Load Wire (Note: The color of your wire may be different from the color shown on the manual.)

Verify power is off

We recommend you remove the faceplate from the old switch and use an electrical tester to test all wires connected to the switch to ensure there is no voltage in the circuit.

You may need to turn off more than one circuit breaker.

Warnings:

- Installation must be carried out by a qualified electrician in accordance with local regulations.
- Keep the device out of the reach of children.
- Keep the device away from water, damp or hot environment.
- Install the device away from strong signal sources such as microwave oven that may cause signal interruption resulted in abnormal operation of the device.
- Obstruction by concrete wall or metallic materials may reduce the effective operation range of the device and should be avoided.
- Do NOT attempt to disassemble, repair or modify the device.

2Gang Smart Dimmer Module

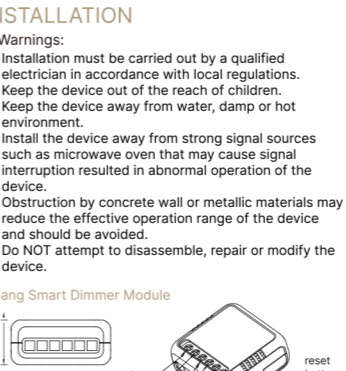

TECHNICAL SPECIFICATIONS

Model	ZM-105B-M
Product type	Smart Dimmer Module
Voltage	90-250V AC
Max Power	2*50W 110V / 2*100W 220V
Wireless Protocol	ZigBee 3.0
Operation temp.	-0°C - +40°C
Case temp.	Tc: +80°C (Max.)
Dims (WxDxH)	40×40×18 mm
IP rating	IP20

WIRING DIAGRAM

1. With two 1 Gang switch

2. Without switch

3. With 3 Way switches

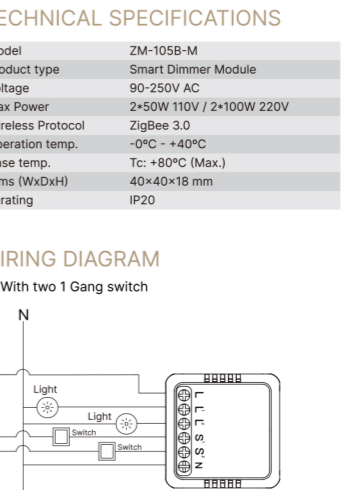

2. Without switch

3. With 3 Way switches

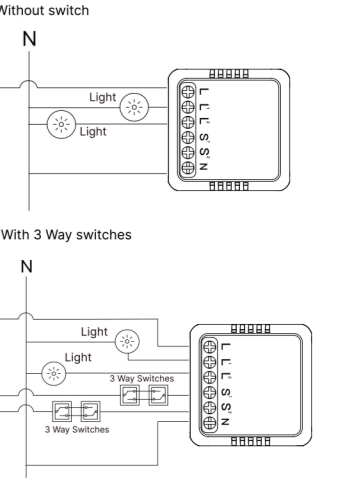

Wiring Instructions and Diagrams

- Turn off the power supply before carrying out any electrical installation work.
- Connect wires according to the wiring diagram.
- Insert the module into the junction box.
- Connect the power supply and follow switch module con guration instructions.

Notes: Put your smartphone close to the switch module when you're configuring, and make sure you have min. 50% Wi-Fi signal.

FAQ

Q1: What should I do if I can't configure the switch module?

- Please check whether device is powered on.
- Make sure your ZigBee gateway is online
- Whether it's in good internet conditions.
- Make sure the password entered in App is correct.
- Make sure the wiring is correct.

Q2: What device can be connected to this ZigBee switch module?

Most of your household electrical appliances can be, such as lamps, laundry machine, coffe maker, etc.

Q3: What happens if the WiFi goes off?

You can still control the device connected to the switch module with your traditional switch and once WiFi is active again the devices connected to App will connect automatically for normal control.

Q4: What should I do if I change the WiFi network or change the password?

You have to re-connect your Zigbee gateway hub to the new WiFi network according to the App User Manual.

Q5: How do I reset the device?

Power on/off device 10 times until the beeper on the module sounds continuously.

Add Devices

1 Download Smart Life App

Please scan the QR code or download Smart Life on App store.

2 Registration or Log in.

Download "Smart Life" Application - Enter the Register/Login interface; tap "Register" to create an account by entering your phone number to get verification code and "Set password". Choose "Log in" if you already have a Smart Life account.



Add Device

NOTE: Please make sure that the smart ZigBee gateway device is within the coverage range of your home's 2.4G WiFi and has been successfully connected to the Smart Life APP.

Method one: Scan the QR code to configure the network guide.



Method two:

- Please make sure that your Smart Life app lication has successfully connected to the Zigbee gateway.

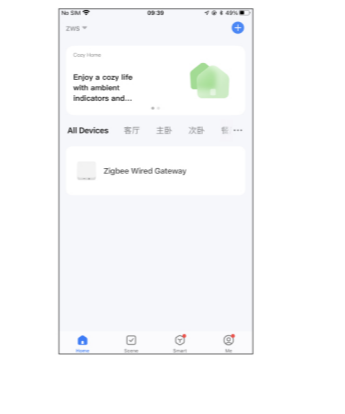

2. Reset:

Reset Switch

Note: This smart switch module can only be used with reset switch.

- For switch module:** Press the reset button on the module for a long time until the beep sounds continuously and quickly for pairing and reset mode.
- For switch module:** Press the reset button on the module for a long time until the beep sounds continuously and quickly for pairing and reset mode.
- For reset switch:** press the switch button for 10 times until the beep sounds continuously and rapidly as Di-Di-Di... for pairing and reset mode.

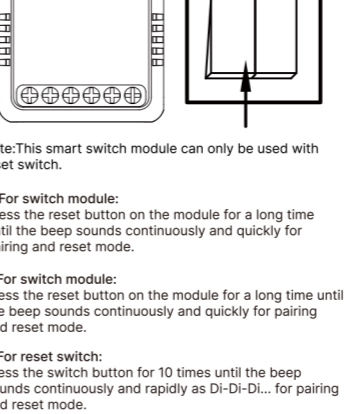

3. Enter the gateway. Please follow the picture below to finish as "Add subdevice → LED already blink, and the connecting will take about 10-120 secondsto complete depending on your network condition.

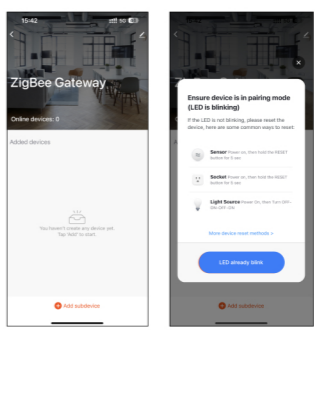

4. Add the device successfully, you can edit the name of the device to enter the device page by click "Done".

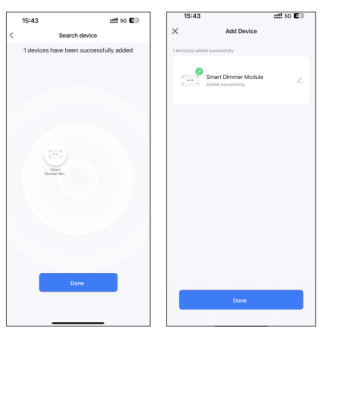

5. Click "Done" to enter the device page to enjoy your smart life with home automation.

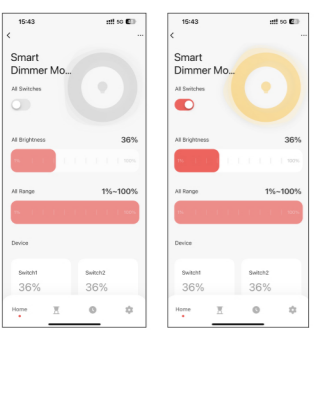

How to achieve multi-control association (only for N+L wire)

Note: Please confirm you have successfully finished the link method above for adding this switch to your Smart Life App before the association.

- Add another smart switch to the same Smart Life App. (If there is a smart switch having been added before to the app, just go to next step.)

Note: If your switch requires a neutral wire, then there is no need to wire the new added switch to the light, only L and N are required for wiring. Then you can control 1 light with multiple switches in Smart Life App.

If your switch doesn't requires a neutral wire, you need to follow the wiring instructions to connect the L and light. At this point, you can control the lights simultaneously with multiple switches.

- Then you will see two devices in the app and click the main switch (as one gang switch as below) by entering into the next operation.

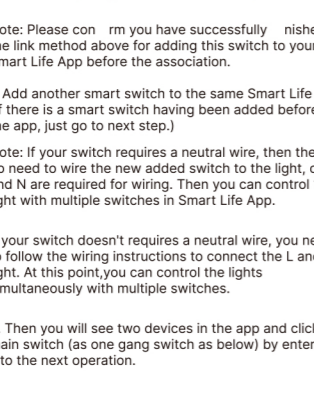

New Added Switch

Main Switch

3. Click √ in the upper right corner and choose "Multi-Control Association, and then click "+" in the right corner.



4. Choose the switch that you want to associate to and then choose the switch button that you want to control the same light. Then go back to previous page, you will see two items in the page, one is your main switch, the other is the one you associate just now.

Note: Please confirm the associated switch is enabled.

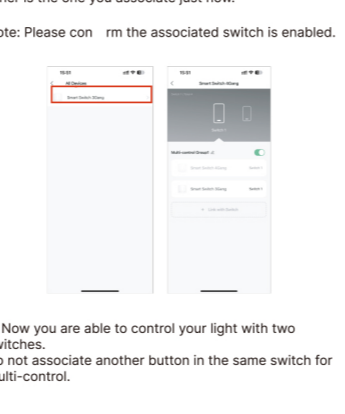

5. Now you are able to control your light with two switches. Do not associate another button in the same switch for multi-control.

6. If you want to add another third or more smart switches to control your light, just repeat the steps above. And you will see the result as below when you associate another new switch.

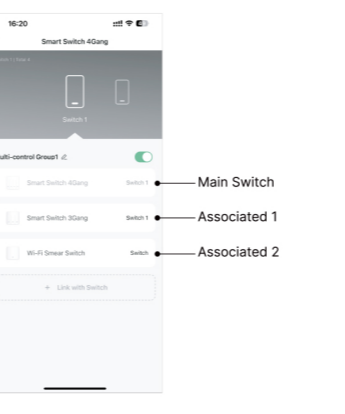

Enter Smart Life Skill in Alexa APP

- Complete product networking configuration in the App according to the prompts in the App. Note: In the App, change the name of the device to an easily identifiable name such as Alexa; names are usually in English, such as "bed light".
- How to connect Smart Device to Amazon Alexa.

- Launch Smart Life App, sign into your account and make sure Smart Device is on the device list
- Minimize Smart Life App, then launch the Alexa App and sign in your Alexa account and make sure you have at least one Alexa smart speaker-controlled device installed like Echo dot, etc.



3. In the upper left corner of Home page, press the button to show APP Menu. Then select in the menu.

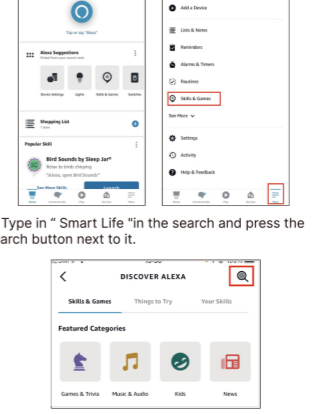

4. Type in "Smart Life" in the search and press the search button next to it.

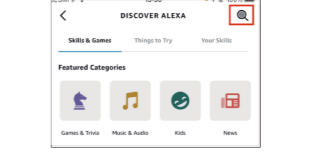

5. Enable Smart Life Smart Skill then sign in your Smart Life account to complete your account set up.

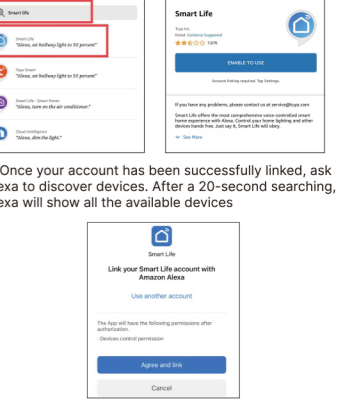

6. Once your account has been successfully linked, ask Alexa to discover devices. After a 20-second searching, Alexa will show all the available devices

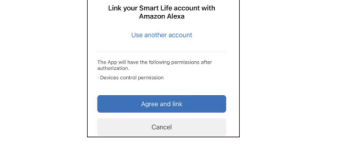

7. In the Smart Home page, you can group your devices in different categories. Your Smart Life APP has now been paired with Alexa. Now you can control your Smart Device through Alexa.



3. How to connect Smart Device to Google Home

- Launch the Google Home App and make sure Google Home speaker is installed. If not, please follow Google Home speaker installation instruction to complete the installation.
- Open the Google Home app and click on the plus sign in the top left corner to enter the "add and manage" page, then click on "Set up device".



3. Enter "smart life" in the search box and then search for it. Enable smart life smart skills, and then log in to your moes account to complete the account setup. After successfully logging into your account, you need to wait 20 seconds to search for devices. Once the device is successfully discovered, it means that your smart life app has been paired with Google Home, and all available smart devices are displayed on the homepage upon returning. Now you can use Google Home to control your smart devices.

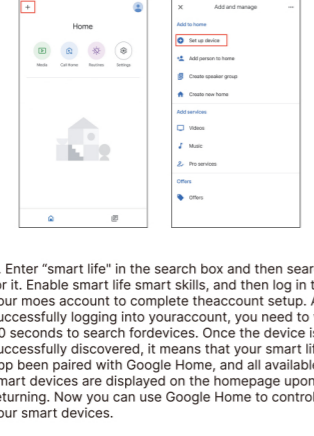

SERVICE

Thank you for your trust and support to our products, we will provide you with a two-year worry-free after-sales service (freight is not included), please do not alter this warranty service card, to safeguard your legitimate rights and interests. If you need service or have any questions, please consult the distributor or contact us. Product quality problems occur within 24 months from the date of receipt, please prepare the product and the packaging, applying for after-sales maintenance in the site or store where you purchase; If the product is damaged due to personal reasons, a certain amount of maintenance fee shall be charged for repair. We have the right to refuse to provide warranty service if:

- Products with damaged appearance, missing LOGO or beyond the service term.
- Products that are disassembled, injured, privately repaired, modified or have missing parts.
- The circuit is burned or the data cable or power interface is damaged.
- Products damaged by foreign matter intrusion (including but not limited to various forms of fluid, sand, dust, soot, etc.)

RECYCLING INFORMATION

All products marked with the symbol for separate collection of waste electrical and electronic equipment (WEEE Directive 2012/19 / EU) must be disposed of separately from unsorted municipal waste. To protect your health and the environment, this equipment must be disposed of at designated collection points for electrical and electronic equipment designated by the government or local authorities. Correct disposal and recycling will help prevent potential negative consequences for the environment and human health. To find out where these collection points are and how they work, contact the installer or your local authority.



WARRANTY CARD

Product Information

Product Name _____

Product Type _____

Purchase Date _____

Warranty Period _____

Dealer Information

Customer's Name _____

Customer Phone _____

Customer Address _____

Maintenance Records

Failure date	Cause Of Issue	Fault Content	Principal

WARRANTY CARD

Product Information

Product Name _____

Product Type _____

Purchase Date _____

Warranty Period _____

Dealer Information

Customer's Name _____

Customer Phone _____

Customer Address _____

Maintenance Records

Failure date	Cause Of Issue	Fault Content	Principal

WARRANTY CARD

Product Information

Product Name _____

Product Type _____

Purchase Date _____

Warranty Period _____

Dealer Information

Customer's Name _____

Customer Phone _____

Customer Address _____

Maintenance Records

Failure date	Cause Of Issue	Fault Content	Principal

WARRANTY CARD

Product Information

Product Name _____

Product Type _____

Purchase Date _____

Warranty Period _____

Dealer Information

Customer's Name _____

Customer Phone _____

Customer Address _____

Maintenance Records

Failure date	Cause Of Issue	Fault Content	Principal