



Via Giovanni Keplero, 22 20019 Settimo Milanese (MI), Italia
P.IVA 07212330968

Tel: +39 0289550782

Whatsapp: +39 3343516911

E-mail: info@a2zworld.com

Website: www.meanwell.it

Indice

Interruttore Magnetotermico Automatico (MCB)

GAX2 + GAX4 (SB6L)	01
GAX2 + GAX4 (PB8H)	08
GAX7 (PN8H)	15

Interruttore Magnetotermico Differenziale (RCBO)

GB5 (PL8HM)	22
GB6 (PL8M4)	29
GB7 (PL8HT)	36

Interruttore Differenziale Puro (RCCB)

GC5 + GC6 (PR8HM)	41
GC5 + GC6 (PR8NM)	48

Altri

GD2 + GD4 (DH)	54
GF5 + GF6 (N8UE1)	58
GF5 + GF6 + GF7 (N8UE2)	60
GH1 (HC-225)	62

Interruttore Magnetotermico Automatico (MCB)

Interruttore Magnetotermico Automatico secondo IEC/EN 60898-1

Potere di interruzione nominale 6000A

Versioni da 1 a 4 poli

Tipologia Curva B, Curva C e Curva D

Corrente Nominale fino a 63A

Voltaggio Nominale 230/400V AC



Interruttore Magnetotermico Automatico è un interruttore elettrico azionato automaticamente progettato per proteggere un circuito elettrico da danni causati da correnti in eccesso dovute a sovraccarico o cortocircuito. La sua funzione principale è interrompere il flusso di corrente dopo che è stato rilevato un guasto. Sono comuni in applicazioni domestiche, commerciali e industriali.

Può anche essere utilizzato per operazioni di accensione e spegnimento non frequenti in condizioni normali.

Struttura dello SKU

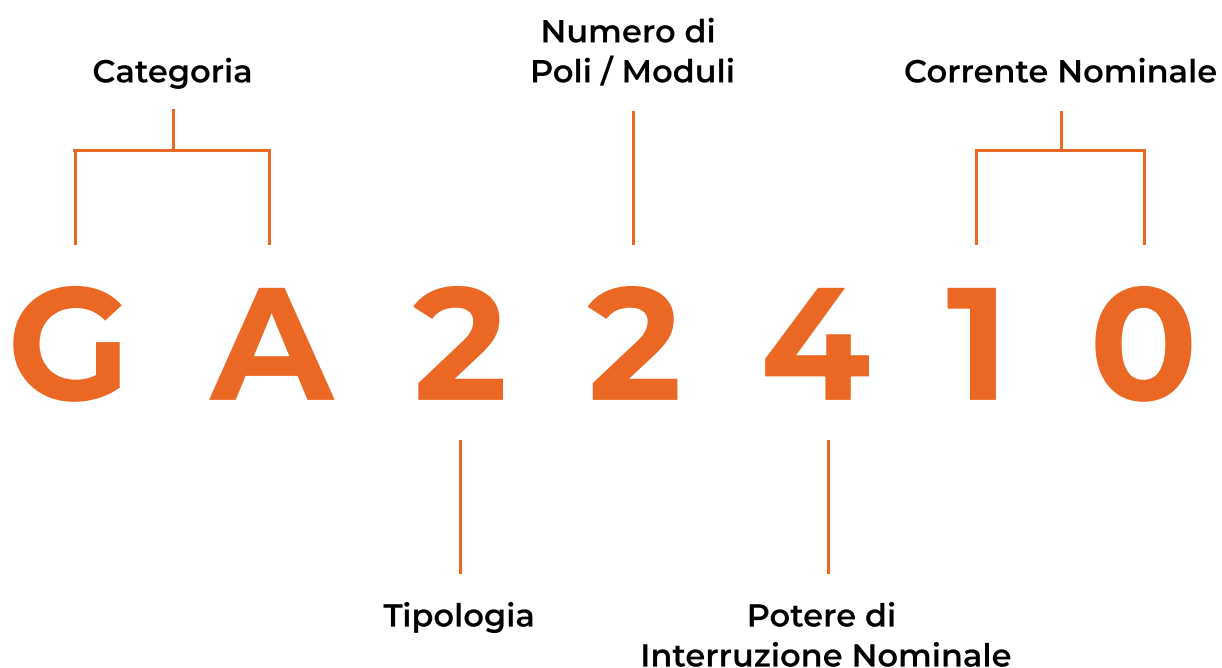

SKU	Categoria	Tipologia	Poli/Moduli	Interruzione	Corrente Nominale
GA22410	MCB	Curva B	2P 2M	6000A	10A
GA22416	MCB	Curva B	2P 2M	6000A	16A
GA22420	MCB	Curva B	2P 2M	6000A	20A
GA22425	MCB	Curva B	2P 2M	6000A	25A
GA22432	MCB	Curva B	2P 2M	6000A	32A
GA22440	MCB	Curva B	2P 2M	6000A	40A
GA22450	MCB	Curva B	2P 2M	6000A	50A
GA22463	MCB	Curva B	2P 2M	6000A	63A
GA32410	MCB	Curva C	2P 2M	6000A	10A
GA32416	MCB	Curva C	2P 2M	6000A	16A
GA32420	MCB	Curva C	2P 2M	6000A	20A
GA32425	MCB	Curva C	2P 2M	6000A	25A
GA32432	MCB	Curva C	2P 2M	6000A	32A
GA32440	MCB	Curva C	2P 2M	6000A	40A
GA32450	MCB	Curva C	2P 2M	6000A	50A
GA32463	MCB	Curva C	2P 2M	6000A	63A
GA34410	MCB	Curva C	4P 4M	6000A	10A
GA34416	MCB	Curva C	4P 4M	6000A	16A
GA34420	MCB	Curva C	4P 4M	6000A	20A
GA34425	MCB	Curva C	4P 4M	6000A	25A
GA34432	MCB	Curva C	4P 4M	6000A	32A
GA34440	MCB	Curva C	4P 4M	6000A	40A
GA34450	MCB	Curva C	4P 4M	6000A	50A
GA34463	MCB	Curva C	4P 4M	6000A	63A

** Si informa che tutti gli articoli sopra indicati ** sono disponibili. Su richiesta, è possibile fornire ulteriori varianti o soluzioni personalizzate per soddisfare esigenze specifiche.

Product Tips

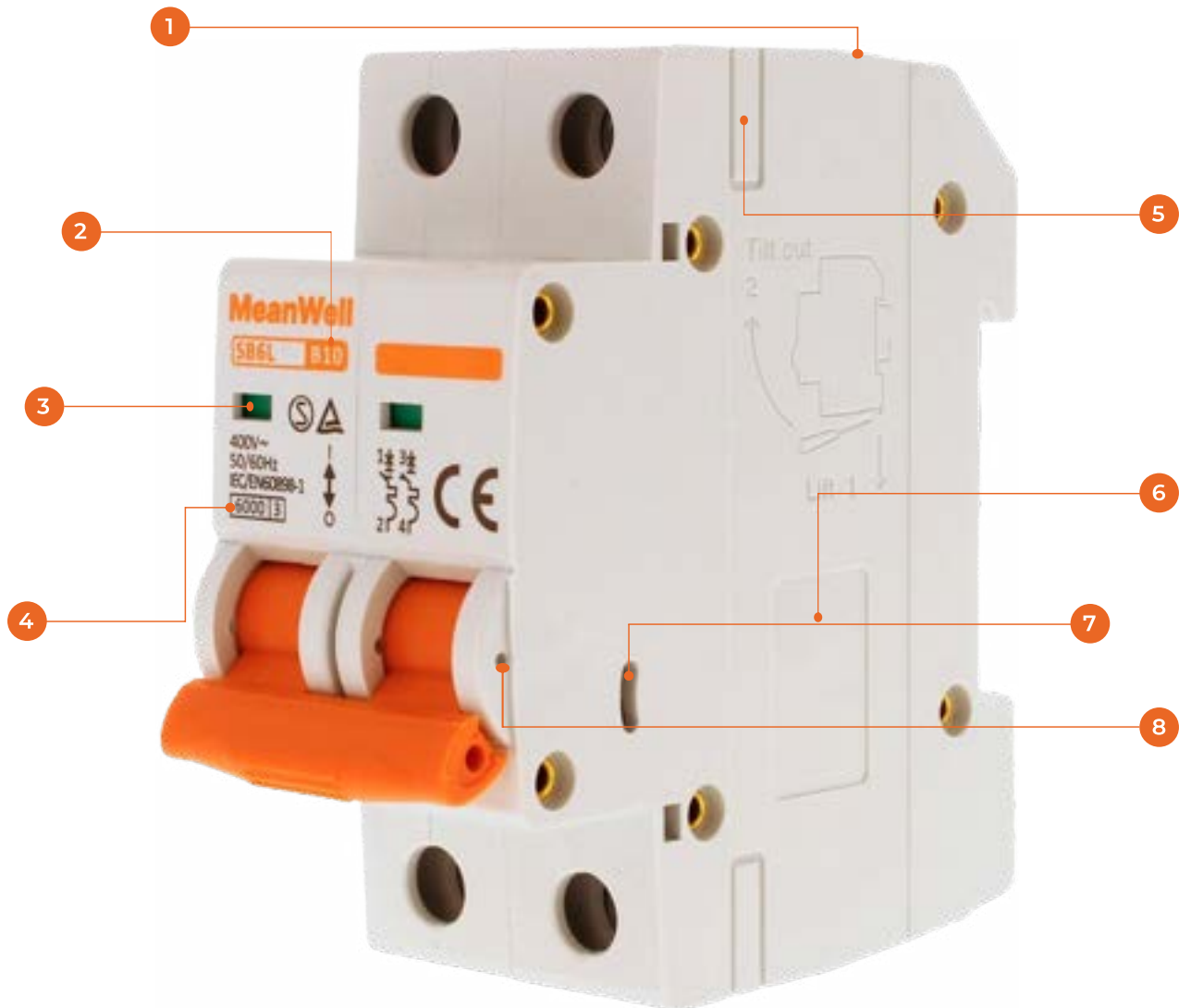

- | | |
|--|---|
| <p>1 Reversible line and load connection</p> | <p>5 Busbar interface</p> |
| <p>2 Tripping characteristics B, C, D</p> | <p>6 Modifiable modules for ODM clients</p> |
| <p>3 Contacts position indication window</p> | <p>7 Wide range of accessories</p> |
| <p>4 Rated short circuit breaking capacity 6000A</p> | <p>8 The position of handle lock</p> |

Technical Data

Electrical Features		
International standard		IEC/EN 60898-1
Poles		1P, 1P+N, 2P, 3P, 3P+N, 4P
Rated current		1-63A
Tripping characteristics		B, C, D
Rated breaking capacity	I_{cn}	6kA
Rated operational voltage	U_e	230/400V AC
Minimum operational voltage	U_{min}	12V AC
Maximum operational voltage	U_{max}	440V AC
Rated frequency		50/60Hz
Rated insulated voltage	U_i	500V AC
Rated impulse withstand voltage	U_{imp}	6kV
Dielectric test voltage		2kV
Mechanical service life		10000 operation cycles
Electrical service life		4000 operation cycles
Line voltage connection		Arbitrary above or below

Combination with Accessories	
Auxiliary contact	Yes
Alarm contact	Yes
Shunt release	Yes
Shunt release + Aux	Yes
Undervoltage release	Yes
Overvoltage release	Yes
Over & under voltage release	Yes

Technical Data

Installation Parameters	
Degree of protection (IP)	IP20, IP40 (when fitted)
Operating ambient temperature	-25°C ~+70°C
Terminal connection type	Cable/Busbar
Connectable conductor cross section	1-25mm ²
Mounting	IEC/EN 60715 top-hat rail 35mm
Fastening torque of terminals	2-3.0N.m
Pollution degree	2
Reference temperature for setting of thermal element	30°C
Altitude	≤ 2000m
Relative humidity	≤ 95%
Resistance to humidity and heat	Class 2
Installation class	III

Dimensions

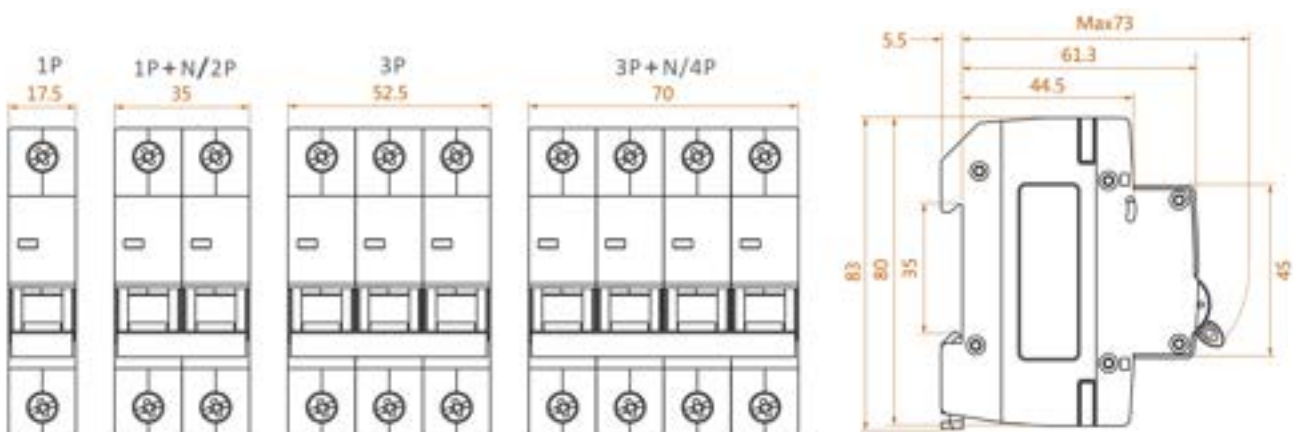

Technical Data

Wiring Diagrams



1P

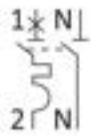

1P+N



2P



3P



3P+N



4P

Tripping Characteristics

Characteristic B

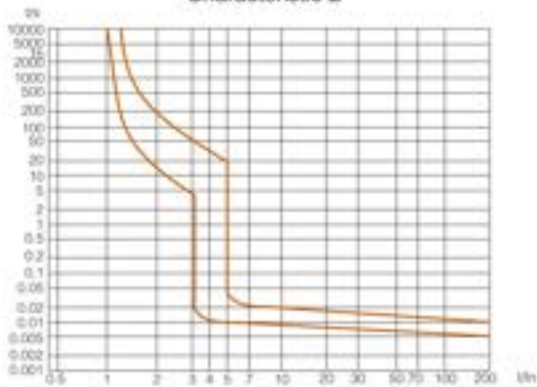

Characteristic C

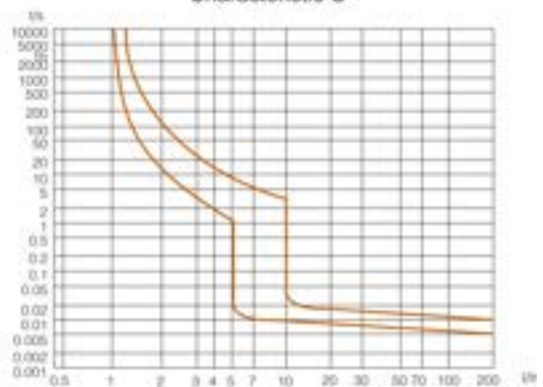

Characteristic D

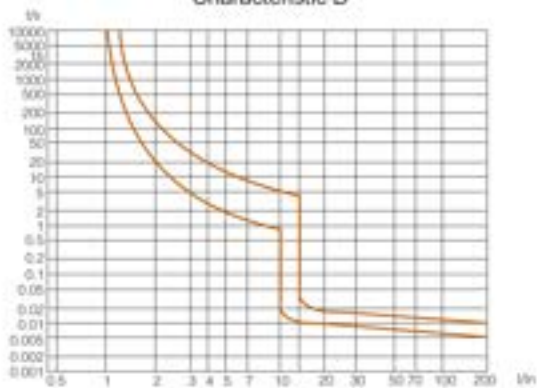

Technical Data

Dependence of Tripping Characteristics on Ambient Temperature

T [°C]	In (T) [A]														
	1 A	2 A	3 A	4 A	6 A	8 A	10 A	13 A	16 A	20 A	25 A	32 A	40 A	50 A	63 A
-30	1.3	2.5	3.8	5.1	7.6	10.2	13.6	16.8	20.5	25.3	31.1	40.5	51.0	64.0	82.0
-25	1.2	2.4	3.7	4.9	7.4	9.9	13.4	16.5	20.0	25.0	30.5	39.8	50.0	63.0	80.7
-20	1.2	2.4	3.6	4.8	7.3	9.7	13.1	16.3	19.8	24.5	30.0	39.2	49.2	62.0	79.2
-15	1.2	2.4	3.5	4.8	7.2	9.5	12.8	15.9	19.4	24.0	29.5	38.5	48.4	60.8	77.8
-10	1.2	2.3	3.5	4.7	7.1	9.3	12.5	15.7	19.0	23.7	29.0	37.9	47.5	59.8	76.3
-5	1.2	2.3	3.4	4.7	7.0	9.2	12.3	15.4	18.7	23.2	28.5	37.2	46.7	58.6	74.7
0	1.1	2.2	3.4	4.5	6.8	9.0	12.0	15.0	18.4	22.8	28.0	36.5	45.8	57.4	73.2
5	1.1	2.2	3.3	4.4	6.6	8.9	11.7	14.7	18.0	22.4	27.5	35.8	45.0	56.3	71.6
10	1.1	2.1	3.3	4.3	6.5	8.7	11.4	14.3	17.6	21.9	27.0	35.0	44.0	55.0	70.0
15	1.1	2.1	3.2	4.3	6.4	8.5	11.0	14.0	17.2	21.5	26.5	34.3	43.0	53.8	68.3
20	1.0	2.1	3.2	4.2	6.3	8.3	10.7	13.7	16.8	21.0	26.0	33.6	42.0	52.6	66.6
25	1.0	2.0	3.0	4.1	6.2	8.2	10.4	13.4	16.4	20.5	25.5	32.8	41.0	51.3	64.8
30	1	2	3	4	6	8	10	13	16	20	25	32	40	50	63
35	0.99	2.00	3.00	3.9	5.9	7.9	9.9	12.8	16.0	20.0	25.0	32.0	39.0	49.0	62.0
40	0.97	1.90	2.90	3.9	5.8	7.8	9.7	12.5	15.0	19.0	24.0	31.0	39.0	48.0	61.0
45	0.95	1.90	2.80	3.8	5.7	7.7	9.5	12.2	15.0	19.0	24.0	30.0	38.0	47.0	60.0
50	0.93	1.90	2.80	3.7	5.6	7.6	9.3	12.0	15.0	19.0	23.0	30.0	37.0	46.0	58.0
55	0.91	1.80	2.80	3.6	5.5	7.5	9.0	11.7	14.0	18.0	23.0	29.0	36.0	44.0	57.0
60	0.91	1.80	2.70	3.5	5.4	7.2	8.8	11.5	14.0	18.0	22.0	28.0	35.0	42.0	55.0
65	0.91	1.80	2.70	3.5	5.3	7.1	8.6	11.2	13.0	17.0	21.0	28.0	34.0	40.0	52.0
70	0.91	1.80	2.70	3.5	5.3	6.9	8.6	11.0	13.0	17.0	21.0	27.0	33.0	38.0	50.0

Power Loss per Pole

In [A]	1 A	2 A	3 A	4 A	6 A	8 A	10 A	13 A	16 A	20 A	25 A	32 A	40 A	50 A	63 A
P[W]	1.5	2.0	1.8	2.0	2.2	2.6	1.5	1.7	1.7	2.0	2.2	2.6	2.9	3.8	4.4

Interruttore Magnetotermico Automatico (MCB)

Interruttore Magnetotermico Automatico secondo IEC/EN 60898-1

Potere di interruzione nominale 10000A

Versioni da 1 a 4 poli

Tipologia Curva B, Curva C e Curva D

Corrente Nominale fino a 63A

Voltaggio Nominale 230/400V AC



Interruttore Magnetotermico Automatico (MCB) è un interruttore elettrico azionato automaticamente progettato per proteggere un circuito elettrico dai danni causati da un eccesso di corrente dovuto a sovraccarico o cortocircuito. La sua funzione principale è interrompere il flusso di corrente dopo che è stato rilevato un guasto. È comunemente utilizzato in applicazioni domestiche, commerciali e industriali.

Può essere impiegato anche per operazioni di accensione e spegnimento non frequenti in condizioni normali.

Struttura dello SKU



SKU	Categoria	Tipologia	Poli/Moduli	Interruzione	Corrente Nominale
GA32510	MCB	Curva C	2P 2M	10000A	10A
GA32516	MCB	Curva C	2P 2M	10000A	16A
GA32520	MCB	Curva C	2P 2M	10000A	20A
GA32525	MCB	Curva C	2P 2M	10000A	25A
GA32532	MCB	Curva C	2P 2M	10000A	32A
GA32540	MCB	Curva C	2P 2M	10000A	40A
GA32550	MCB	Curva C	2P 2M	10000A	50A
GA32563	MCB	Curva C	2P 2M	10000A	63A
GA34510	MCB	Curva C	4P 4M	10000A	10A
GA34516	MCB	Curva C	4P 4M	10000A	16A
GA34520	MCB	Curva C	4P 4M	10000A	20A
GA34525	MCB	Curva C	4P 4M	10000A	25A
GA34532	MCB	Curva C	4P 4M	10000A	32A
GA34540	MCB	Curva C	4P 4M	10000A	40A
GA34550	MCB	Curva C	4P 4M	10000A	50A
GA34563	MCB	Curva C	4P 4M	10000A	63A

** Si informa che tutti gli articoli sopra indicati sono disponibili. Su richiesta, è possibile fornire ulteriori varianti o soluzioni personalizzate per soddisfare esigenze specifiche.

Product Tips

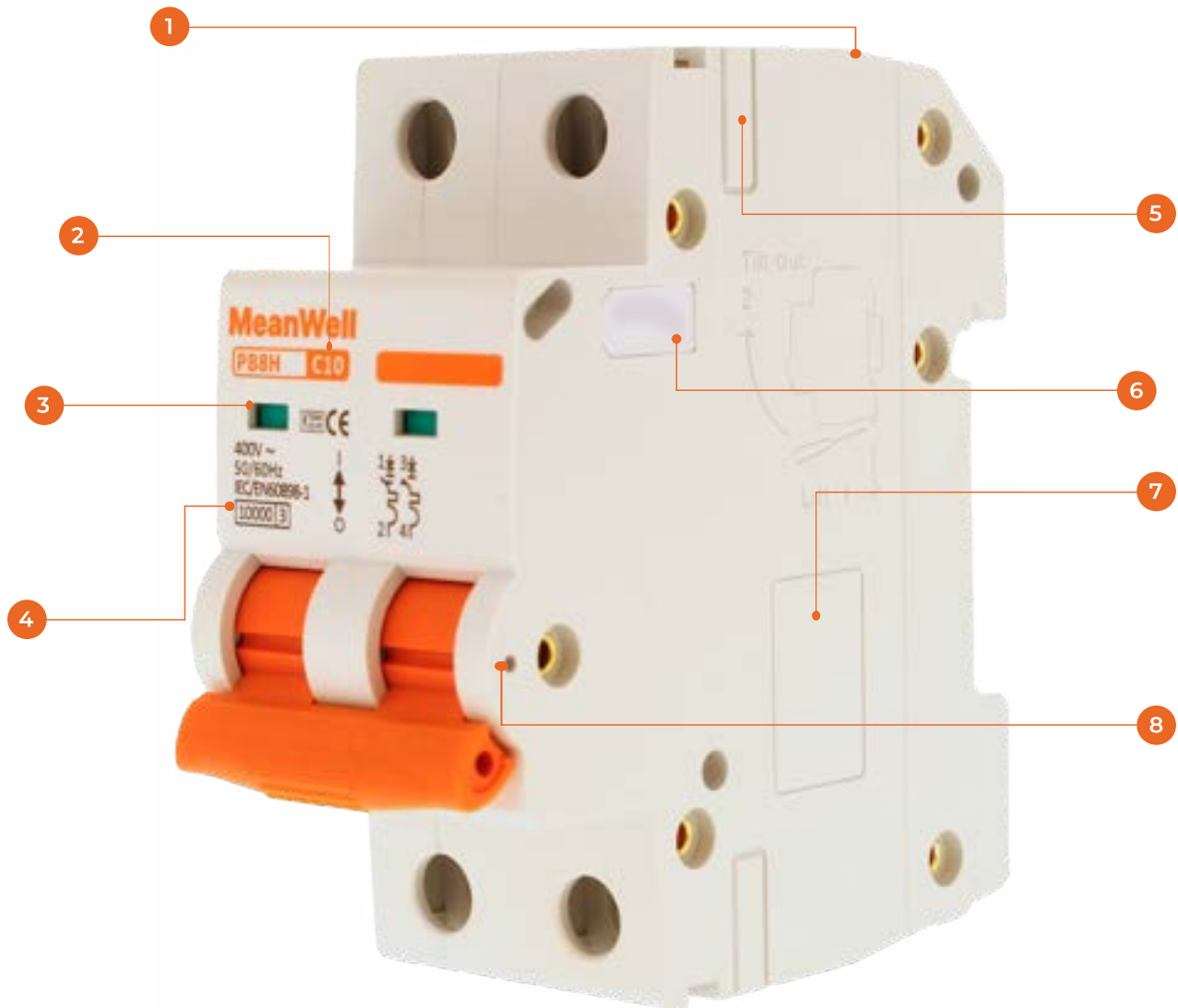

- | | |
|--|--------------------------------------|
| 1 Reversible line and load connection | 5 Busbar interface |
| 2 Tripping characteristics B, C, D | 6 Wide range of accessories |
| 3 Contacts position indication window | 7 Modifiable modules for ODM clients |
| 4 Rated short circuit breaking capacity 10000A | 8 The position of handle lock |

Technical Data

Electrical Features		
International standard		IEC/EN 60898-1
Poles		1P, 1P+N, 2P, 3P, 3P+N, 4P
Rated current		1-63A
Tripping characteristics		B, C, D
Rated breaking capacity	I_{cn}	10kA
Rated operational voltage	U_e	230/400V AC
Minimum operational voltage	U_{min}	12V AC
Maximum operational voltage	U_{max}	440V AC
Rated frequency		50/60Hz
Rated insulated voltage	U_i	500V AC
Rated impulse withstand voltage	U_{imp}	6kV
Dielectric test voltage		2kV
Mechanical service life		10000 operation cycles
Electrical service life		4000 operation cycles
Line voltage connection		Arbitrary above or below

Combination with Accessories	
Auxiliary contact	Yes
Alarm contact	Yes
Shunt release	Yes
Shunt release + Aux	Yes
Undervoltage release	Yes
Overvoltage release	Yes
Over & under voltage release	Yes

Technical Data

Installation Parameters	
Degree of protection (IP)	IP20, IP40 (when fitted)
Operating ambient temperature	-25°C ~+70°C
Terminal connection type	Cable/Busbar
Connectable conductor cross section	1-25mm ²
Mounting	IEC/EN 60715 top-hat rail 35mm
Fastening torque of terminals	2-3.0N.m
Pollution degree	2
Reference temperature for setting of thermal element	30°C
Altitude	≤ 2000m
Relative humidity	≤ 95%
Resistance to humidity and heat	Class 2
Installation class	III

Dimensions

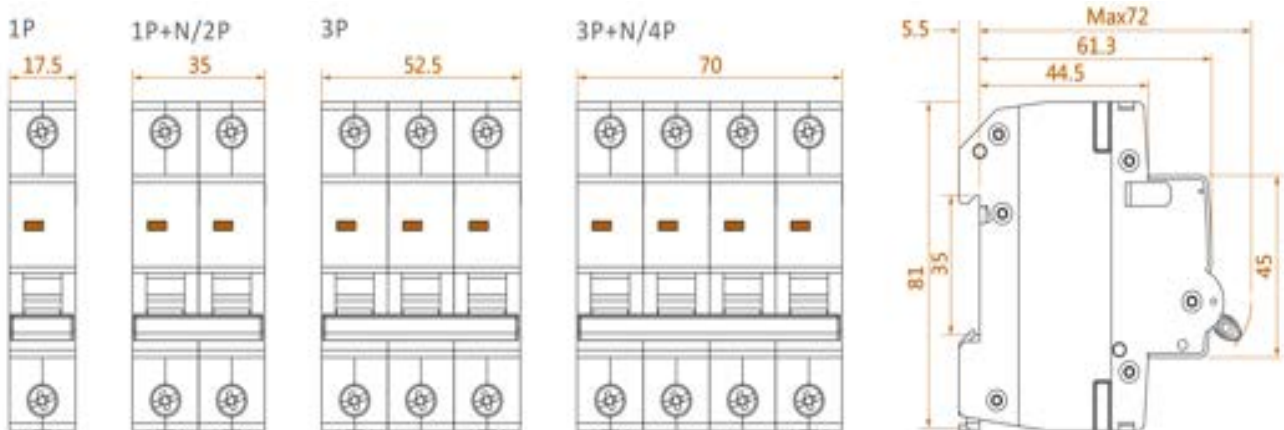

Technical Data

Wiring Diagrams



1P

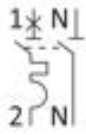

1P+N



2P



3P



3P+N

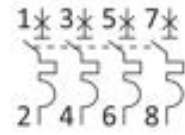

4P

Tripping Characteristics

Characteristic B

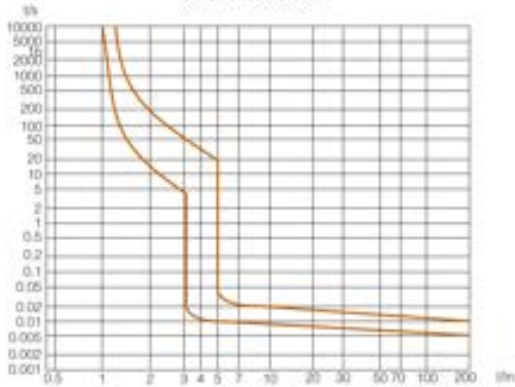

Characteristic C

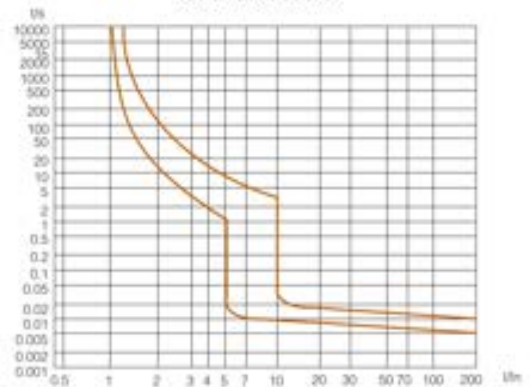

Characteristic D

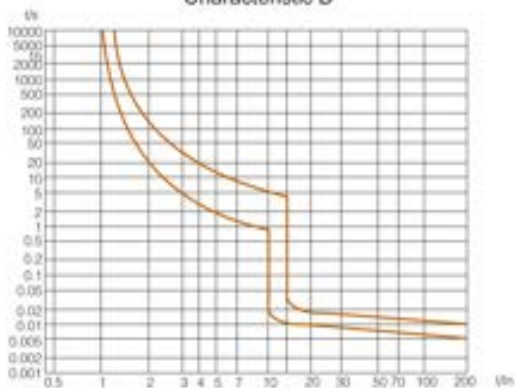

Technical Data

Dependence of Tripping Characteristics on Ambient Temperature

T [°C]	In (T) [A]														
	1 A	2 A	3 A	4 A	6 A	8 A	10 A	13 A	16 A	20 A	25 A	32 A	40 A	50 A	63 A
-30	1.3	2.5	3.8	5.1	7.6	10.2	13.6	16.8	20.5	25.3	31.1	40.5	51.0	64.0	82.0
-25	1.2	2.4	3.7	4.9	7.4	9.9	13.4	16.5	20.0	25.0	30.5	39.8	50.0	63.0	80.7
-20	1.2	2.4	3.6	4.8	7.3	9.7	13.1	16.3	19.8	24.5	30.0	39.2	49.2	62.0	79.2
-15	1.2	2.4	3.5	4.8	7.2	9.5	12.8	15.9	19.4	24.0	29.5	38.5	48.4	60.8	77.8
-10	1.2	2.3	3.5	4.7	7.1	9.3	12.5	15.7	19.0	23.7	29.0	37.9	47.5	59.8	76.3
-5	1.2	2.3	3.4	4.7	7.0	9.2	12.3	15.4	18.7	23.2	28.5	37.2	46.7	58.6	74.7
0	1.1	2.2	3.4	4.5	6.8	9.0	12.0	15.0	18.4	22.8	28.0	36.5	45.8	57.4	73.2
5	1.1	2.2	3.3	4.4	6.6	8.9	11.7	14.7	18.0	22.4	27.5	35.8	45.0	56.3	71.6
10	1.1	2.1	3.3	4.3	6.5	8.7	11.4	14.3	17.6	21.9	27.0	35.0	44.0	55.0	70.0
15	1.1	2.1	3.2	4.3	6.4	8.5	11.0	14.0	17.2	21.5	26.5	34.3	43.0	53.8	68.3
20	1.0	2.1	3.2	4.2	6.3	8.3	10.7	13.7	16.8	21.0	26.0	33.6	42.0	52.6	66.6
25	1.0	2.0	3.0	4.1	6.2	8.2	10.4	13.4	16.4	20.5	25.5	32.8	41.0	51.3	64.8
30	1	2	3	4	6	8	10	13	16	20	25	32	40	50	63
35	0.99	2.00	3.00	3.9	5.9	7.9	9.9	12.8	16.0	20.0	25.0	32.0	39.0	49.0	62.0
40	0.97	1.90	2.90	3.9	5.8	7.8	9.7	12.5	15.0	19.0	24.0	31.0	39.0	48.0	61.0
45	0.95	1.90	2.80	3.8	5.7	7.7	9.5	12.2	15.0	19.0	24.0	30.0	38.0	47.0	60.0
50	0.93	1.90	2.80	3.7	5.6	7.6	9.3	12.0	15.0	19.0	23.0	30.0	37.0	46.0	58.0
55	0.91	1.80	2.80	3.6	5.5	7.5	9.0	11.7	14.0	18.0	23.0	29.0	36.0	44.0	57.0
60	0.91	1.80	2.70	3.5	5.4	7.2	8.8	11.5	14.0	18.0	22.0	28.0	35.0	42.0	55.0
65	0.91	1.80	2.70	3.5	5.3	7.1	8.6	11.2	13.0	17.0	21.0	28.0	34.0	40.0	52.0
70	0.91	1.80	2.70	3.5	5.3	6.9	8.6	11.0	13.0	17.0	21.0	27.0	33.0	38.0	50.0

Power Loss per Pole

In [A]	1 A	2 A	3 A	4 A	6 A	8 A	10 A	13 A	16 A	20 A	25 A	32 A	40 A	50 A	63 A
P[W]	1.5	2.0	1.8	2.0	2.2	2.6	1.5	1.7	1.7	2.0	2.2	2.6	2.9	3.8	4.4

Interruttore Magnetotermico Automatico (MCB)

Interruttore Magnetotermico Automatico secondo IEC/EN 60898-1

Potere di interruzione nominale 6000A

1+N poli in un modulo.

Tipologia Curva B e Curva C

Corrente Nominale fino a 32A

Voltaggio Nominale 230/400V AC



Interruttore Magnetotermico Automatico (MCB) è un interruttore elettrico automatico progettato per proteggere un circuito elettrico dai danni causati da correnti eccessive dovute a sovraccarico o cortocircuito. La sua funzione di base è interrompere il flusso di corrente una volta rilevato un guasto. È comunemente utilizzato in applicazioni domestiche, commerciali e industriali.

Può essere utilizzato anche per operazioni di accensione e spegnimento non frequenti in condizioni normali.

Struttura dello SKU

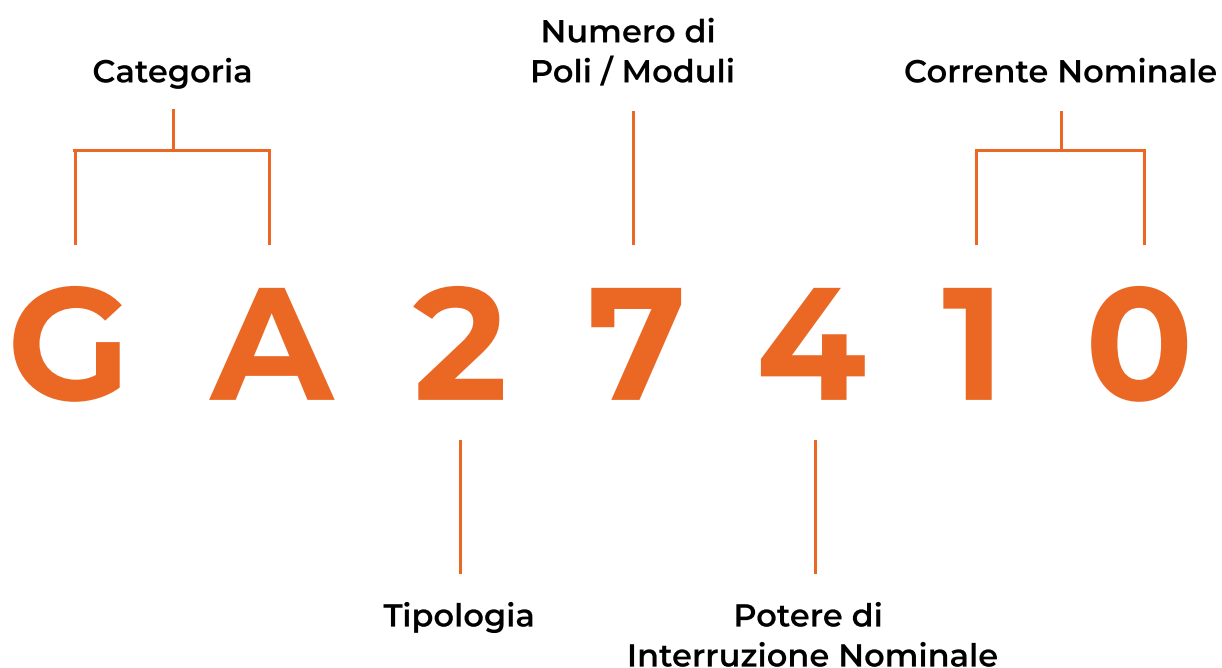

SKU	Categoria	Tipologia	Poli/Moduli	Interruzione	Corrente Nominale
GA27410	MCB	Curva B	1P + N, 2M	6000A	10A
GA27416	MCB	Curva B	1P + N, 2M	6000A	16A
GA27420	MCB	Curva B	1P + N, 2M	6000A	20A
GA27425	MCB	Curva B	1P + N, 1M	6000A	25A
GA27432	MCB	Curva B	1P + N, 1M	6000A	32A
GA37410	MCB	Curva C	1P + N, 1M	6000A	10A
GA37416	MCB	Curva C	1P + N, 1M	6000A	16A
GA37420	MCB	Curva C	1P + N, 1M	6000A	20A
GA37425	MCB	Curva C	1P + N, 1M	6000A	25A
GA37432	MCB	Curva C	1P + N, 1M	6000A	32A

** Si informa che tutti gli articoli sopra indicati sono disponibili. Su richiesta, è possibile fornire ulteriori varianti o soluzioni personalizzate per soddisfare esigenze specifiche.

Product Tips

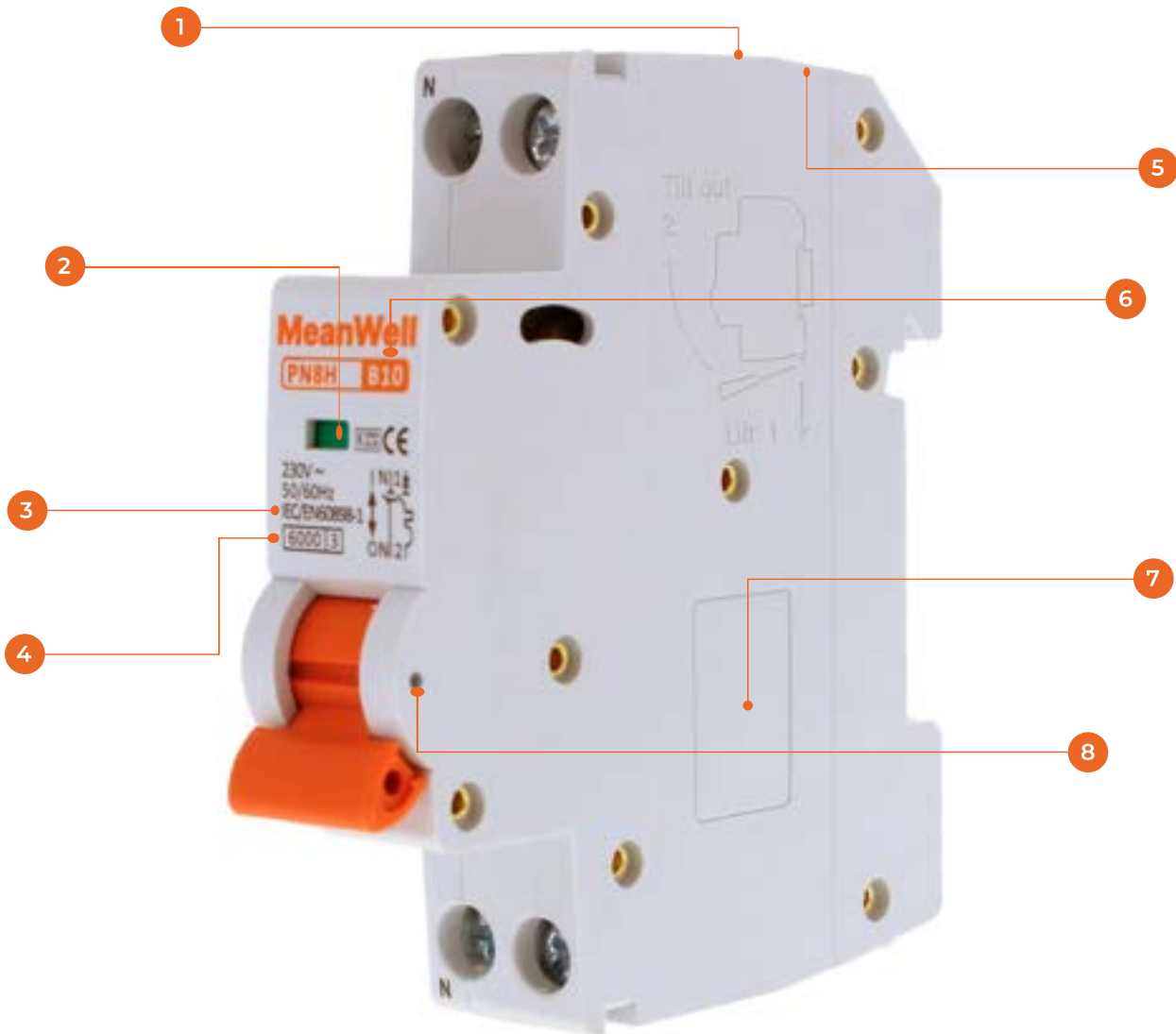

- | | |
|---|--------------------------------------|
| 1 Neutral line interface | 5 Live line interface |
| 2 Contacts position indication window | 6 Tripping characteristics B, C |
| 3 International standards | 7 Modifiable modules for ODM clients |
| 4 Rated short circuit breaking capacity 6000A | 8 The position of handle lock |

Technical Data

Electrical Features		
International standard		IEC/EN 60898-1
Poles		1P+N
Rated current		1-32A
Tripping characteristics		B, C
Rated breaking capacity	I_{cn}	6kA
Rated operational voltage	U_e	230V AC
Minimum operational voltage	U_{min}	12V AC
Maximum operational voltage	U_{max}	240V AC
Rated frequency		50/60Hz
Rated insulated voltage	U_i	400V AC
Rated impulse withstand voltage	U_{imp}	4kV
Dielectric test voltage		2kV
Mechanical service life		10000 operation cycles
Electrical service life		4000 operation cycles
Line voltage connection		Arbitrary above or below

Combination with Accessories	
Auxiliary contact	Yes
Alarm contact	Yes
Shunt release	Yes
Shunt release + Aux	Yes
Undervoltage release	Yes
Overvoltage release	Yes
Over & under voltage release	Yes

Technical Data

Installation Parameters	
Degree of protection (IP)	IP20, IP40 (when fitted)
Operating ambient temperature	-25°C ~+70°C
Terminal connection type	Cable
Connectable conductor cross section	1-10mm ²
Mounting	IEC/EN 60715 top-hat rail 35mm
Fastening torque of terminals	2.0N.m
Pollution degree	2
Reference temperature for setting of thermal element	30°C
Altitude	≤ 2000m
Relative humidity	≤ 95%
Resistance to humidity and heat	Class 2
Installation class	III

Dimensions

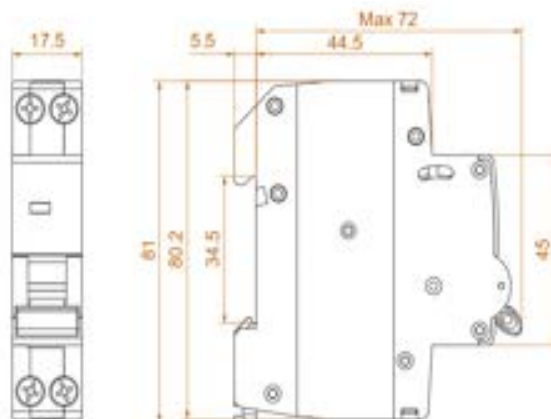

Technical Data

Wiring Diagrams



Tripping Characteristics

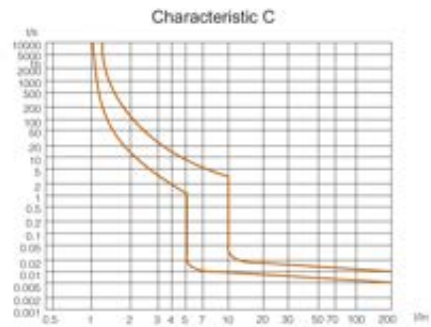
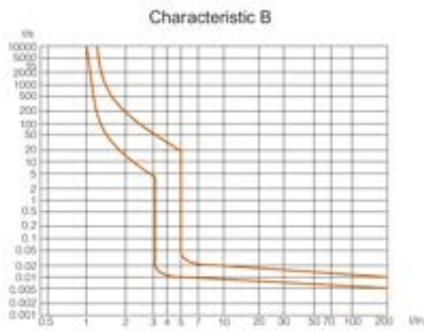

Technical Data

Dependence of Tripping Characteristics on Ambient Temperature

T [°C]	In (T) [A]									
	1 A	2 A	3 A	4 A	6 A	10 A	16 A	20 A	25 A	32 A
-20	1.35	2.6	4.1	5.3	8	13.5	20	24.5	29.8	39.5
-15	1.28	2.53	4.05	5.15	7.8	13.3	19.8	24.3	29.7	39.3
-10	1.25	2.4	3.95	5.08	7.6	13	19.5	24	29.5	39
-5	1.2	2.33	3.9	4.98	7.3	12.7	19.2	23.8	29.3	38.8
0	1.18	2.3	3.8	4.8	7.2	12.5	19.1	23.7	29.2	38.6
5	1.15	2.28	3.6	4.72	7	12.3	18.8	23.5	29	38.4
10	1.1	2.23	3.45	4.65	6.8	12.1	18.6	23.3	28.8	38.2
15	1.08	2.18	3.35	4.52	6.6	12	18.5	23.1	28.6	38
20	1.05	2.09	3.22	4.31	6.4	11.8	18.3	22.8	28.4	37.8
25	1.05	2.03	3.08	4.22	6.2	11.5	18	22.6	28.2	37.5
30	1	2	3	4	6	10	16	20	25	32
35	0.99	1.98	2.98	3.95	6	9.9	15.7	19.7	24.6	31.5
40	0.97	1.95	2.95	3.91	5.9	9.8	15.4	19.3	24.3	31.1
45	0.95	1.91	2.91	3.85	5.83	9.8	15.1	18.8	24	30.8
50	0.91	1.88	2.88	3.8	5.72	9.6	14.9	18.5	23.8	30.1
55	0.89	1.85	2.82	3.74	5.65	9.5	14.7	18.2	23.5	29.5
60	0.86	1.81	2.77	3.71	5.5	9	14.5	17.8	23	28.5
65	0.84	1.77	2.73	3.65	5.4	8.6	14	17.5	22	27.5
70	0.81	1.71	2.65	3.52	5.2	8	13.8	17.3	21.5	27

Interruttore Magnetotermico Differenziale (RCBO)

Interruttore Magnetotermico Differenziale conforme alla norma IEC/EN 61009-1.

Tipo elettromagnetico

Potere di interruzione nominale 6000A

Versione 1+N poli

Polo N a destra

Corrente differenziale nominale 30, 100, 300mA

Corrente Nominale fino a 40A

Larghezza di 2 moduli

Tipi AC e A



Gli interruttori differenziali sono basati sulla combinazione di un dispositivo differenziale con il principio del magnete permanente e un interruttore con sgancio termico per sovraccarico e sgancio magnetico per cortocircuito. Offrono il vantaggio del funzionamento indipendente dalla tensione del dispositivo differenziale.

Sono comunemente utilizzati in applicazioni domestiche, commerciali e industriali.

Struttura dello SKU



SKU	Categoria	Tipologia	Poli/Moduli	Interruzione	Corrente Nominale
GB55306	RCBO	Tipo AC Curva C	1P + N, 2M	6000A	6A
GB55310	RCBO	Tipo AC Curva C	1P + N, 2M	6000A	10A
GB55316	RCBO	Tipo AC Curva C	1P + N, 2M	6000A	16A
GB55320	RCBO	Tipo AC Curva C	1P + N, 2M	6000A	20A
GB55325	RCBO	Tipo AC Curva C	1P + N, 2M	6000A	25A
GB55332	RCBO	Tipo AC Curva C	1P + N, 2M	6000A	32A
GB55606	RCBO	Tipo AC Curva C	1P + N, 2M	6000A	6A
GB55610	RCBO	Tipo AC Curva C	1P + N, 2M	6000A	10A
GB55616	RCBO	Tipo AC Curva C	1P + N, 2M	6000A	16A
GB55620	RCBO	Tipo AC Curva C	1P + N, 2M	6000A	20A
GB55625	RCBO	Tipo AC Curva C	1P + N, 2M	6000A	25A
GB55632	RCBO	Tipo AC Curva C	1P + N, 2M	6000A	32A
GB65306	RCBO	Tipo A Curva C	1P + N, 2M	6000A	6A
GB65310	RCBO	Tipo A Curva C	1P + N, 2M	6000A	10A
GB65316	RCBO	Tipo A Curva C	1P + N, 2M	6000A	16A
GB65320	RCBO	Tipo A Curva C	1P + N, 2M	6000A	20A
GB65325	RCBO	Tipo A Curva C	1P + N, 2M	6000A	25A
GB65332	RCBO	Tipo A Curva C	1P + N, 2M	6000A	32A

** Si informa che tutti gli articoli sopra indicati sono disponibili. Su richiesta, è possibile fornire ulteriori varianti o soluzioni personalizzate per soddisfare esigenze specifiche.

Product Tips

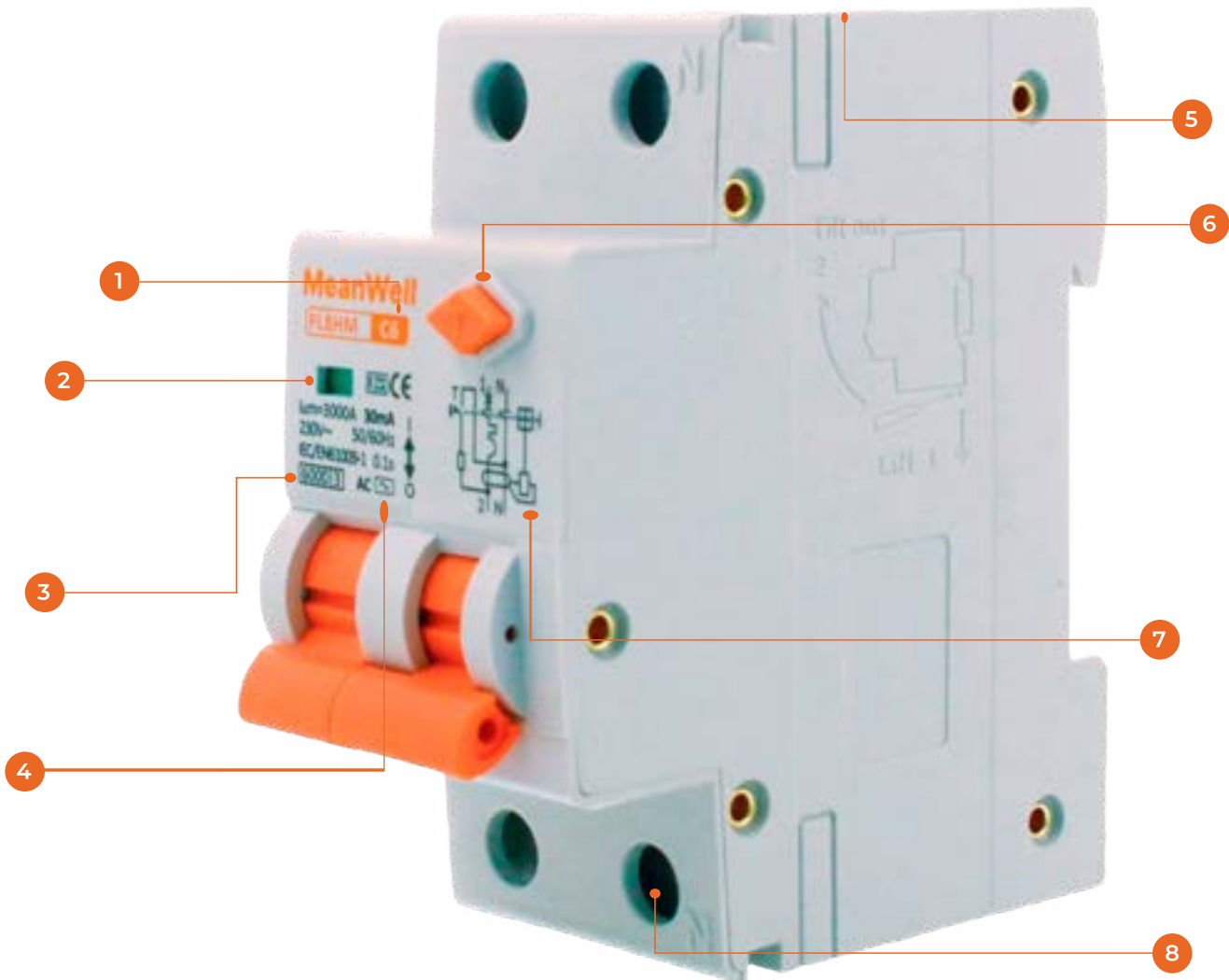

- | | |
|---|--|
| 1 Rated current up to 40A | 5 Busbar interface |
| 2 Contacts position indication window | 6 Test button |
| 3 Rated short circuit breaking capacity 6000A | 7 Electromagnetic circuit diagram with overload protection |
| 4 Sensitivity to residual current A | 8 Neutral line interface |

Technical Data

Electrical Features		
International standard		IEC/EN 61009-1
Poles		1P+N
Rated current		6-40A
Tripping characteristics of MCB		B, C
Rated residual current	$I_{\Delta n}$	30, 100, 300mA
Residual current protection type		Electromagnetic
Rated breaking capacity	I_{cn}	6kA
Rated operational voltage	U_e	230/400V AC
Voltage range of the test button T		195.5 - 253V AC
Sensitivity to residual current		AC type - AC Residual current A type - residual AC and pulsating DC current
Rated frequency		50/60Hz
Rated insulated voltage	U_i	400V AC
Rated impulse withstand voltage	U_{imp}	4kV
Dielectric test voltage		2.5kV
Mechanical service life		10000 operation cycles
Electrical service life		4000 operation cycles
Time characteristic of RCD		Undelayed type
Line voltage connection		Arbitrary above or below

Technical Data

Installation Parameters	
Degree of protection (IP)	IP20, IP40 (when fitted)
Operating ambient temperature	-25°C ~+70°C
Terminal connection type	Cable/Busbar
Connectable conductor cross section	1-25mm ²
Mounting	IEC/EN 60715 top-hat rail 35mm
Fastening torque of terminals	2-3.0N.m
Pollution degree	2
Reference temperature for setting of thermal element	30°C
Altitude	≤ 2000m
Relative humidity	≤ 95%
Resistance to humidity and heat	Class 2
Installation class	III

Dimensions

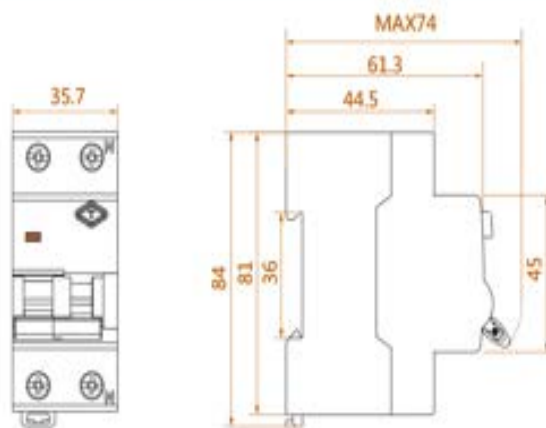

Technical Data

Wiring Diagrams

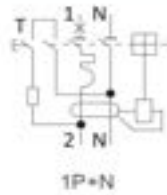

Tripping Characteristics of MCB

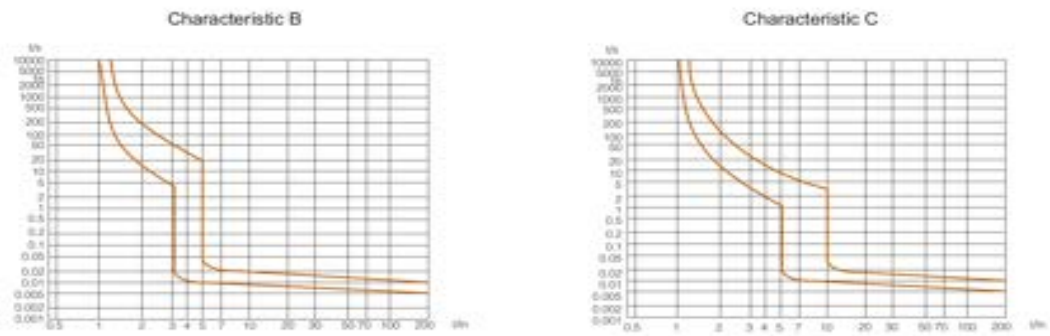

Tripping Characteristics of RCD

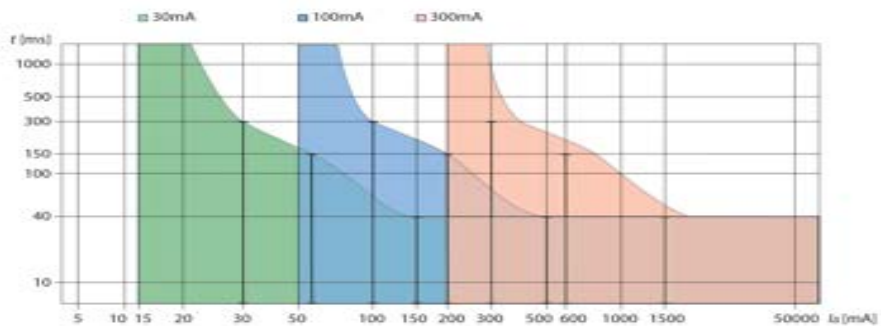

Technical Data

Dependence of Tripping Characteristics on Ambient Temperature

T [°C]	In (T) [A]							
	6 A	10 A	13 A	16 A	20 A	25 A	32 A	40 A
-20	8	13.5	17	20	24.5	29.8	39.5	50.5
-15	7.8	13.3	16.8	19.8	24.3	29.7	39.3	50.4
-10	7.6	13	16.5	19.5	24	29.5	39	50.2
-5	7.3	12.7	16.1	19.2	23.8	29.3	38.8	50
0	7.2	12.5	15.8	19.1	23.7	29.2	38.6	48.8
5	7	12.3	15.5	18.8	23.5	29	38.4	48.6
10	6.8	12.1	15.2	18.6	23.3	28.8	38.2	48.4
15	6.6	12	14.9	18.5	23.1	28.6	38	48.1
20	6.4	11.8	14.7	18.3	22.8	28.4	37.8	47.8
25	6.2	11.5	14.1	18	22.6	28.2	37.5	47
30	6	10	13	16	20	25	32	40
35	6	9.9	12.8	15.7	19.7	24.6	31.5	39.2
40	5.9	9.8	12.5	15.4	19.3	24.3	31.1	38.3
45	5.83	9.8	12.2	15.1	18.8	24	30.8	38.3
50	5.72	9.6	11.7	14.9	18.5	23.8	30.1	38
55	5.65	9.5	11.5	14.7	18.2	23.5	29.5	36.5
60	5.5	9	11.2	14.5	17.8	23	28.5	35
65	5.4	8.6	11	14	17.5	22	27.5	34
70	5.2	8	10.8	13.8	17.3	21.5	27	32.5

Interruttore Magnetotermico Differenziale (RCBO)

Interruttore Magnetotermico Differenziale conforme alla norma IEC/EN 61009-1.

Tipo elettromagnetico

Potere di interruzione nominale 6000A

Versione 3P+N poli

Polo N a sinistra

Corrente differenziale nominale 30, 100, 300mA

Corrente Nominale fino a 40A

Larghezza di 4 moduli

Tipi AC e A

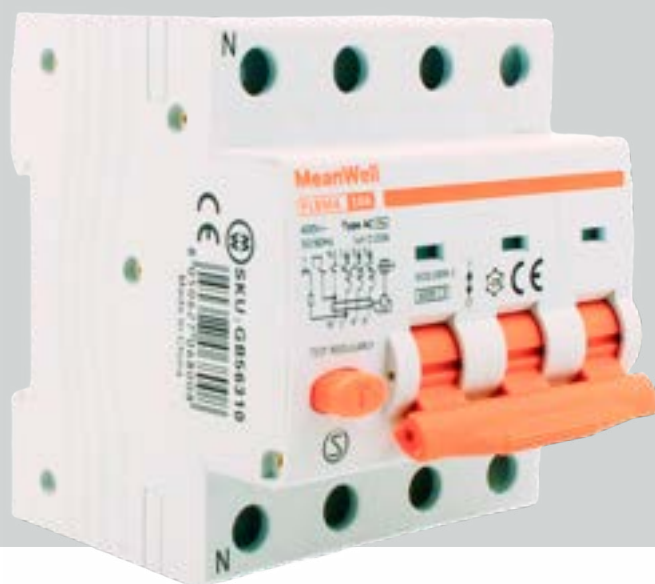

Gli interruttori differenziali sono basati sulla combinazione di un dispositivo differenziale con il principio del magnete permanente e un interruttore con sgancio termico per sovraccarico e sgancio magnetico per cortocircuito. Offrono il vantaggio del funzionamento indipendente dalla tensione del dispositivo differenziale.

Sono comunemente utilizzati in applicazioni domestiche, commerciali e industriali.

Struttura dello SKU



SKU	Categoria	Tipologia	Poli/Moduli	Interruzione	Corrente Nominale
GB56310	RCBO	Tipo AC Curva C	3P + N, 4M	6000A	10A
GB56316	RCBO	Tipo AC Curva C	3P + N, 4M	6000A	16A
GB56320	RCBO	Tipo AC Curva C	3P + N, 4M	6000A	20A
GB56325	RCBO	Tipo AC Curva C	3P + N, 4M	6000A	25A
GB56332	RCBO	Tipo AC Curva C	3P + N, 4M	6000A	32A
GB56340	RCBO	Tipo AC Curva C	3P + N, 4M	6000A	40A
GB56610	RCBO	Tipo AC Curva C	3P + N, 4M	6000A	10A
GB56616	RCBO	Tipo AC Curva C	3P + N, 4M	6000A	16A
GB56620	RCBO	Tipo AC Curva C	3P + N, 4M	6000A	20A
GB56625	RCBO	Tipo AC Curva C	3P + N, 4M	6000A	25A
GB56632	RCBO	Tipo AC Curva C	3P + N, 4M	6000A	32A
GB56640	RCBO	Tipo AC Curva C	3P + N, 4M	6000A	40A
GB66310	RCBO	Tipo A Curva C	3P + N, 4M	6000A	10A
GB66316	RCBO	Tipo A Curva C	3P + N, 4M	6000A	16A
GB66320	RCBO	Tipo A Curva C	3P + N, 4M	6000A	20A
GB66325	RCBO	Tipo A Curva C	3P + N, 4M	6000A	25A
GB66332	RCBO	Tipo A Curva C	3P + N, 4M	6000A	32A
GB66340	RCBO	Tipo A Curva C	3P + N, 4M	6000A	40A

** Si informa che tutti gli articoli sopra indicati sono disponibili. Su richiesta, è possibile fornire ulteriori varianti o soluzioni personalizzate per soddisfare esigenze specifiche.

Product Tips

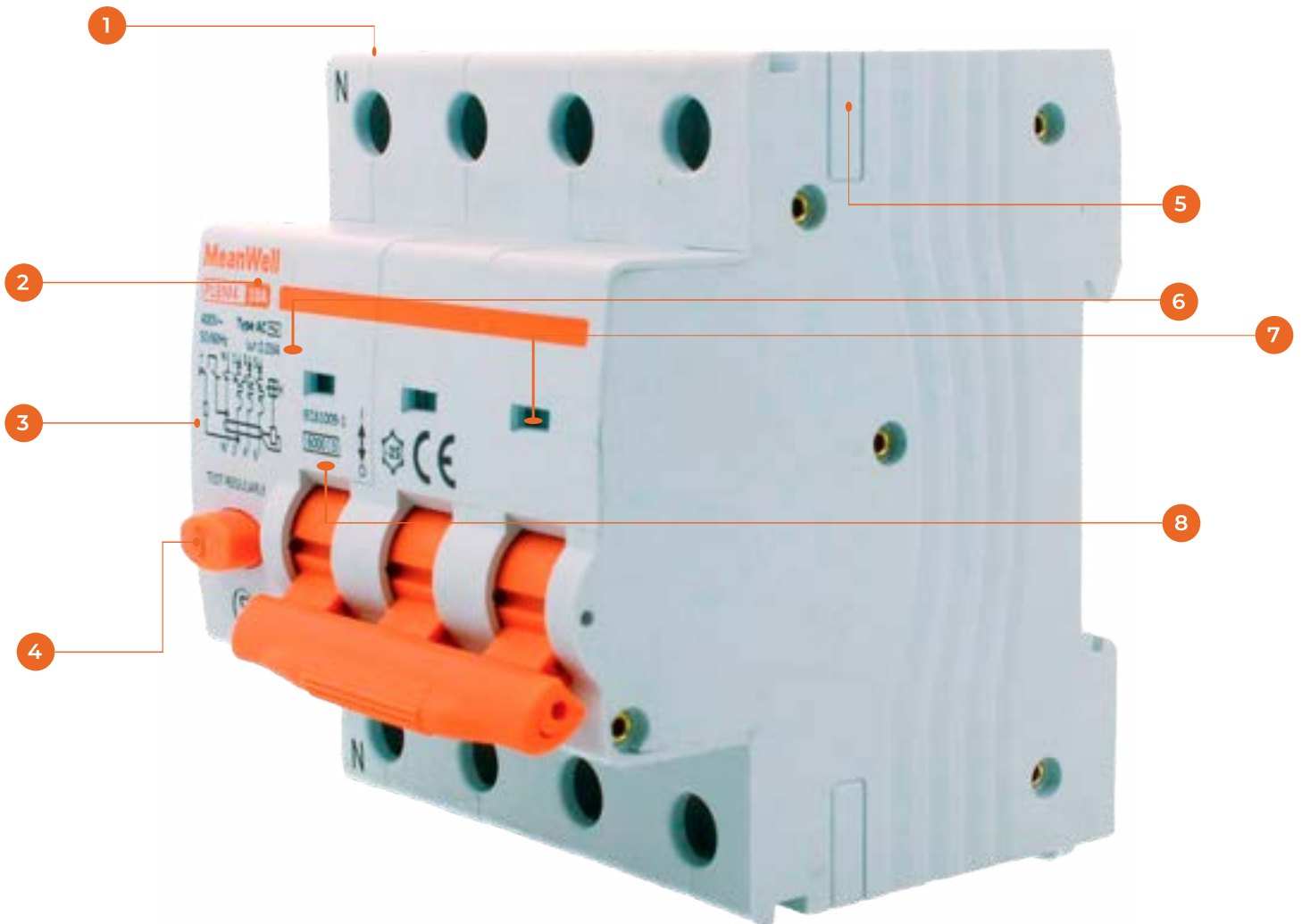

- | | |
|--|---|
| 1 Neutral line interface | 5 Busbar interface |
| 2 Rated current up to 40A | 6 Sensitivity to residual current A |
| 3 Electromagnetic circuit diagram with overload protection | 7 Contacts position indication window |
| 4 Test button | 8 Rated short circuit breaking capacity 6000A |

Technical Data

Electrical Features		
International standard		IEC/EN 61009-1
Poles		3P+N
Rated current		6-40A
Tripping characteristics of MCB		B, C
Rated residual current	$I_{\Delta n}$	30, 100, 300mA
Residual current protection type		Electromagnetic
Rated breaking capacity	I_{cn}	6kA
Rated operational voltage	U_e	230/400V AC
Voltage range of the test button T		195.5 - 253V AC
Sensitivity to residual current		AC type - AC Residual current A type - residual AC and pulsating DC current
Rated frequency		50/60Hz
Rated insulated voltage	U_i	400V AC
Rated impulse withstand voltage	U_{imp}	4kV
Dielectric test voltage		2.5kV
Mechanical service life		10000 operation cycles
Electrical service life		4000 operation cycles
Time characteristic of RCD		Undelayed type
Line voltage connection		Arbitrary above or below

Technical Data

Installation Parameters	
Degree of protection (IP)	IP20, IP40 (when fitted)
Operating ambient temperature	-25°C ~+70°C
Terminal connection type	Cable/Busbar
Connectable conductor cross section	1-25mm ²
Mounting	IEC/EN 60715 top-hat rail 35mm
Fastening torque of terminals	2-3.0N.m
Pollution degree	2
Reference temperature for setting of thermal element	30°C
Altitude	≤ 2000m
Relative humidity	≤ 95%
Resistance to humidity and heat	Class 2
Installation class	III

Dimensions

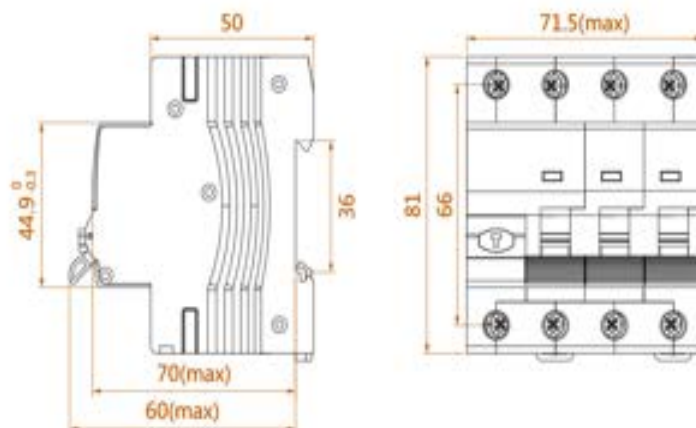

Technical Data

Wiring Diagrams

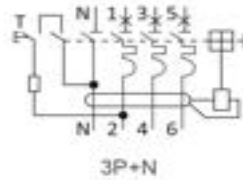

Tripping Characteristics of MCB

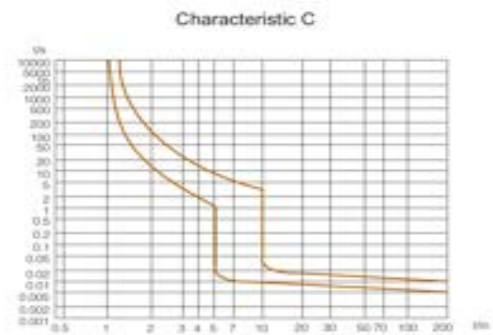
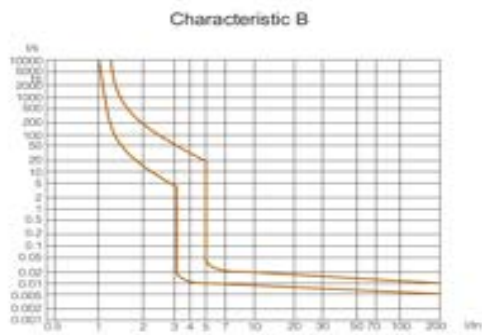

Tripping Characteristics of RCD

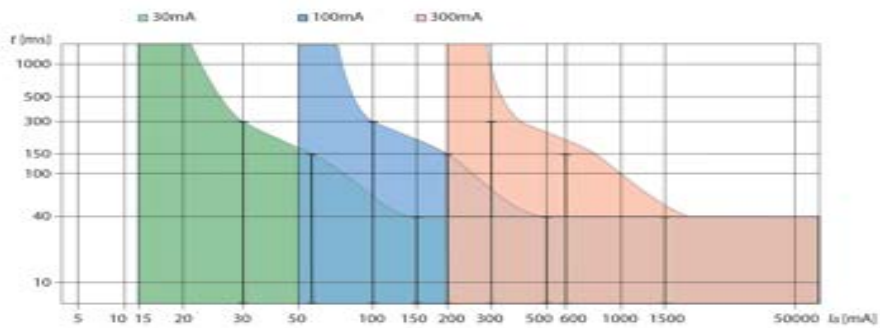

Technical Data

Dependence of Tripping Characteristics on Ambient Temperature

T [°C]	In (T) [A]							
	6 A	10 A	13 A	16 A	20 A	25 A	32 A	40 A
-20	8	13.5	17	20	24.5	29.8	39.5	50.5
-15	7.8	13.3	16.8	19.8	24.3	29.7	39.3	50.4
-10	7.6	13	16.5	19.5	24	29.5	39	50.2
-5	7.3	12.7	16.1	19.2	23.8	29.3	38.8	50
0	7.2	12.5	15.8	19.1	23.7	29.2	38.6	48.8
5	7	12.3	15.5	18.8	23.5	29	38.4	48.6
10	6.8	12.1	15.2	18.6	23.3	28.8	38.2	48.4
15	6.6	12	14.9	18.5	23.1	28.6	38	48.1
20	6.4	11.8	14.7	18.3	22.8	28.4	37.8	47.8
25	6.2	11.5	14.1	18	22.6	28.2	37.5	47
30	6	10	13	16	20	25	32	40
35	6	9.9	12.8	15.7	19.7	24.6	31.5	39.2
40	5.9	9.8	12.5	15.4	19.3	24.3	31.1	38.3
45	5.83	9.8	12.2	15.1	18.8	24	30.8	38.3
50	5.72	9.6	11.7	14.9	18.5	23.8	30.1	38
55	5.65	9.5	11.5	14.7	18.2	23.5	29.5	36.5
60	5.5	9	11.2	14.5	17.8	23	28.5	35
65	5.4	8.6	11	14	17.5	22	27.5	34
70	5.2	8	10.8	13.8	17.3	21.5	27	32.5

Interruttore Magnetotermico Differenziale (RCBO)

Interruttore Magnetotermico Differenziale conforme alla norma IEC/EN 61009-1.

Tipo elettronico

Versione 1P+N poli

Corrente differenziale nominale 30, 100, 300mA

Corrente Nominale fino a 32A

Tipi B e C



Gli interruttori differenziali sono basati sulla combinazione di un dispositivo differenziale con il principio del magnete permanente e un interruttore con sgancio termico per sovraccarico e sgancio magnetico per cortocircuito. Offrono il vantaggio del funzionamento indipendente dalla tensione del dispositivo differenziale.

Sono comunemente utilizzati in applicazioni domestiche, commerciali e industriali.

Struttura dello SKU



SKU	Categoria	Tipologia	Poli/Moduli	Interruzione	Corrente Nominale
GB57306	RCBO	Tipo AC Curva C	1P + N, 1M	6000A	06A
GB57310	RCBO	Tipo AC Curva C	1P + N, 1M	6000A	10A
GB57316	RCBO	Tipo AC Curva C	1P + N, 1M	6000A	16A
GB57320	RCBO	Tipo AC Curva C	1P + N, 1M	6000A	20A
GB57325	RCBO	Tipo AC Curva C	1P + N, 1M	6000A	25A
GB57332	RCBO	Tipo AC Curva C	1P + N, 1M	6000A	32A
GB67306	RCBO	Tipo A Curva C	1P + N, 1M	6000A	06A
GB67310	RCBO	Tipo A Curva C	1P + N, 1M	6000A	10A
GB67316	RCBO	Tipo A Curva C	1P + N, 1M	6000A	16A
GB67320	RCBO	Tipo A Curva C	1P + N, 1M	6000A	20A
GB67325	RCBO	Tipo A Curva C	1P + N, 1M	6000A	25A
GB67332	RCBO	Tipo A Curva C	1P + N, 1M	6000A	32A

** Si informa che tutti gli articoli sopra indicati sono disponibili. Su richiesta, è possibile fornire ulteriori varianti o soluzioni personalizzate per soddisfare esigenze specifiche.

Technical Data

Electrical Features		
International standard		IEC/EN 61009-1
Poles		1P+N
Rated current		6-32A
Tripping characteristics of MCB		B, C
Rated residual current	$I_{\Delta n}$	30, 100, 300mA
Residual current protection type		Electronic
Rated breaking capacity	I_{cn}	6kA
Rated operational voltage	U_e	230/400V AC
Voltage range of the test button T		195.5 - 253V AC
Sensitivity to residual current		AC type - AC Residual current A type - residual AC and pulsating DC current
Rated frequency		50/60Hz
Rated insulated voltage	U_i	400V AC
Rated impulse withstand voltage	U_{imp}	4kV
Dielectric test voltage		2.5kV
Mechanical service life		10000 operation cycles
Electrical service life		4000 operation cycles
Time characteristic of RCD		Undelayed type

Technical Data

Installation Parameters	
Degree of protection (IP)	IP20, IP40 (when fitted)
Operating ambient temperature	-25°C ~+70°C
Terminal connection type	Cable
Connectable conductor cross section	1-10mm ²
Mounting	IEC/EN 60715 top-hat rail 35mm
Fastening torque of terminals	2.0N.m
Pollution degree	2
Reference temperature for setting of thermal element	30°C
Altitude	≤ 2000m
Relative humidity	≤ 95%
Resistance to humidity and heat	Class 2
Installation class	III

Dimensions

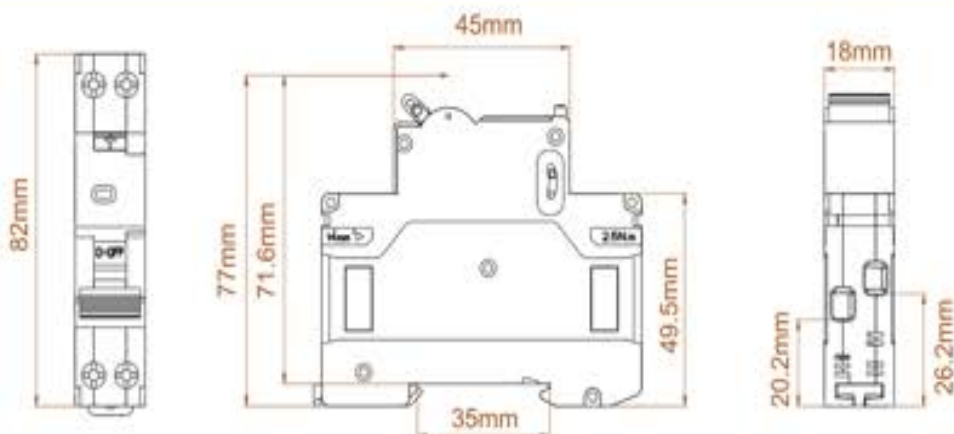

Technical Data

Wiring Diagrams

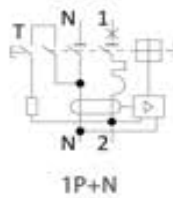

Tripping Characteristics of MCB

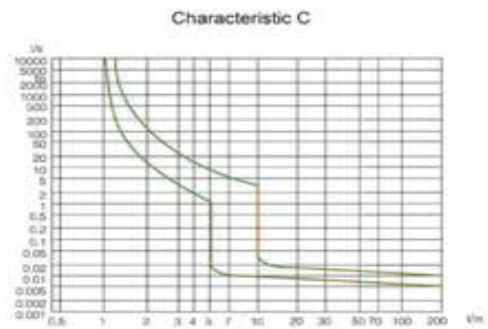
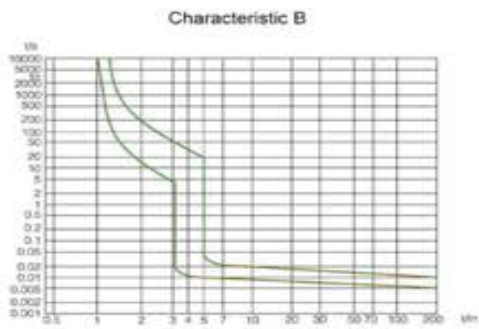

Tripping Characteristics of RCD

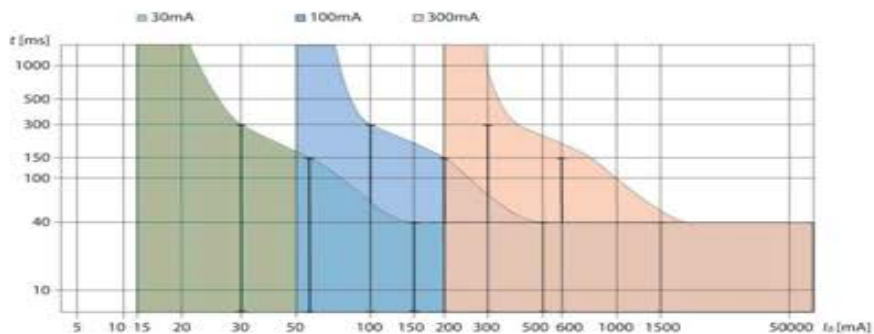

Interruttore Differenziale Puro (RCCB)

Interruttore Differenziale Puro conforme alla norma IEC/EN 61008-1

Tipo elettromagnetico

Condizione di corrente nominale di cortocircuito I_{nc} 10kA

Versioni 1P + N e 3P+N

Corrente differenziale nominale 10, 30, 100, 300mA

Corrente Nominale fino a 100A

Voltaggio Nominale 230/400V AC

Tipi AC, A, S e G



PR8HM Interruttore Differenziale Puro (RCCB) è un dispositivo di sicurezza che interrompe rapidamente un circuito elettrico per proteggere gli apparecchi, progettato per scollegare i cavi conduttori ("scattare") abbastanza velocemente da prevenire potenzialmente lesioni gravi alle persone e danni ai dispositivi elettrici.

È comunemente utilizzato in applicazioni domestiche, commerciali e industriali.

Struttura dello SKU



SKU	Categoria	Tipologia	Poli/Moduli	Interruzione	Corrente Nominale
GC15125	RCCB	Tipo A	1P + N, 2M	10000A	25A
GC15140	RCCB	Tipo A	1P + N, 2M	10000A	40A
GC15163	RCCB	Tipo A	1P + N, 2M	10000A	63A
GC15225	RCCB	Tipo A	1P + N, 2M	10000A	25A
GC15240	RCCB	Tipo A	1P + N, 2M	10000A	40A
GC15263	RCCB	Tipo A	1P + N, 2M	10000A	63A
GC16163	RCCB	Tipo A	3P + N, 4M	10000A	63A
GC16263	RCCB	Tipo A	3P + N, 4M	10000A	63A
GC75125	RCCB	Tipo AC	1P + N, 2M	10000A	25A
GC75140	RCCB	Tipo AC	1P + N, 2M	10000A	40A
GC75163	RCCB	Tipo AC	1P + N, 2M	10000A	63A
GC75225	RCCB	Tipo AC	1P + N, 2M	10000A	25A
GC75240	RCCB	Tipo AC	1P + N, 2M	10000A	40A
GC75263	RCCB	Tipo AC	1P + N, 2M	10000A	63A
GC76163	RCCB	Tipo AC	3P + N, 4M	10000A	63A
GC76263	RCCB	Tipo AC	3P + N, 4M	10000A	63A

** Si informa che tutti gli articoli sopra indicati sono disponibili. Su richiesta, è possibile fornire ulteriori varianti o soluzioni personalizzate per soddisfare esigenze specifiche.

Product Tips

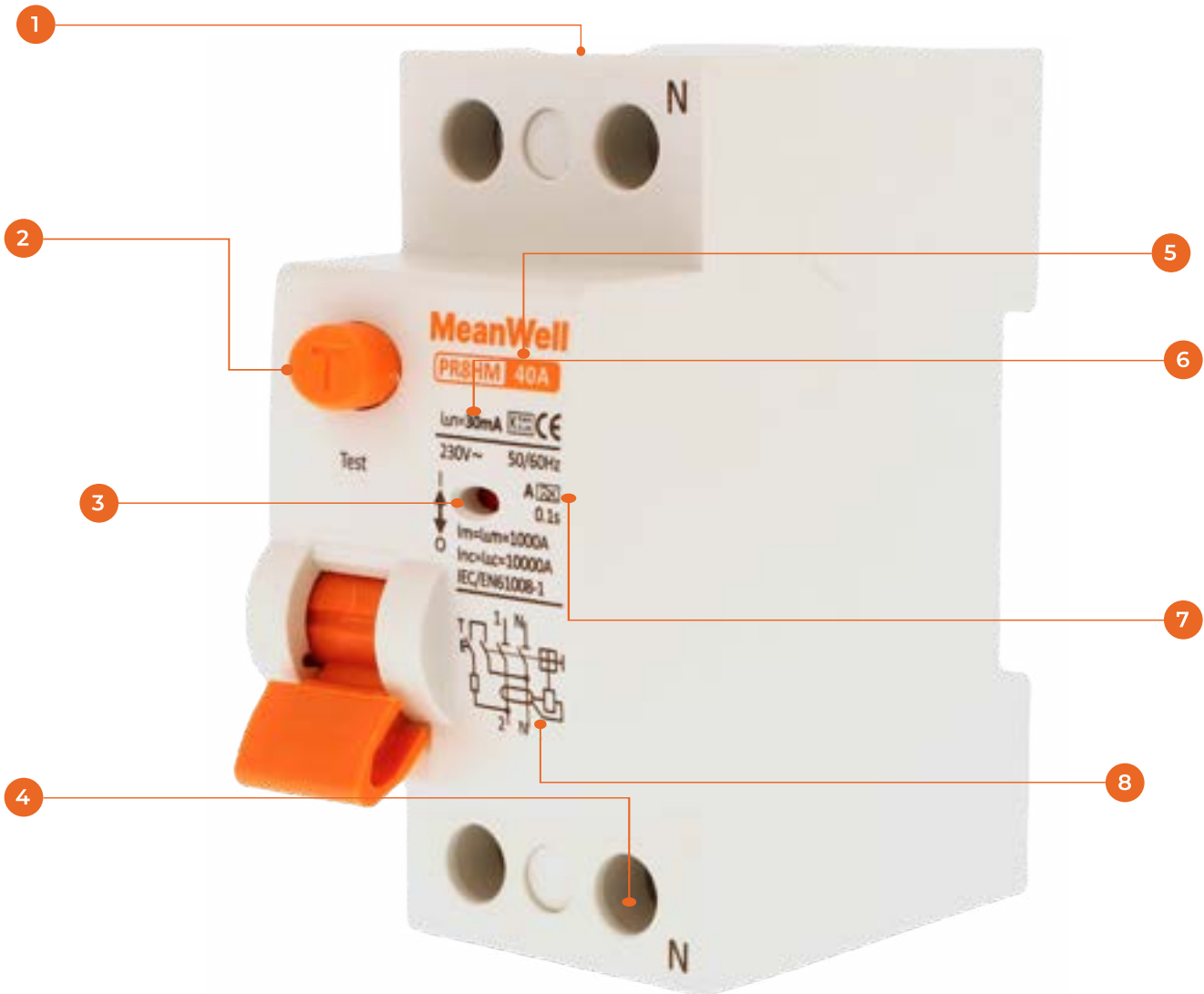

- | | |
|---------------------------------------|--|
| 1 Busbar interface | 5 Rated current up to 100A |
| 2 Test button | 6 Variants from 10 to 300mA $I_{\Delta n}$ available |
| 3 Contacts position indication window | 7 Sensitivity to residual current A |
| 4 Neutral line interface | 8 Electromagnetic circuit diagram |

Technical Data

Electrical Features	
International standard	IEC/EN 61008-1
Poles	1P + N, 3P+N
Rated current	25, 40, 63, 80, 100A
Rated residual current	$I_{\Delta n}$ 10, 30, 100, 300mA
Residual current protection type	Electromagnetic
Conditional short circuit strength	I_{nc} 10kA
Rated operational voltage	U_e 230/400V AC
Min. voltage for RCD function	Independent of voltage
Voltage range of the test button T	150 - 253V AC (1P + N) / 150 - 440V AC (3P + N)
Sensitivity to residual current	AC type - AC Residual current A type - residual AC and pulsating DC current
Time characteristic	AC, A - Undelayed type G - Delay (insensitivity) 10 - 300 ms S - Delay (insensitivity) 130 - 500 ms
Rated frequency	50/60Hz
Rated insulated voltage	U_i 500V AC
Rated impulse withstand voltage	U_{imp} 6kV
Dielectric test voltage	2.5kV
Mechanical service life	10000 operation cycles
Electrical service life	4000 operation cycles
Back up fuse for overload	
$I_n = 25A$	max, 25AgG
$I_n = 40A$	max, 32AgG
$I_n = 63A$	max, 50AgG
$I_n = 80A$	max, 80AgG
$I_n = 100A$	max, 100AgG

Technical Data

Electrical Features

Back up fuse for short circuit	
$I_n = 25A$	max, 63AgG
$I_n = 40A$	max, 63AgG
$I_n = 63A$	max, 63AgG
$I_n = 80A$	max, 80AgG
$I_n = 100A$	max, 100AgG
Rated residual making and breaking capacity I_m / I_{sm}	
$I_n = 25A$	500A
$I_n = 40A$	500A
$I_n = 63A$	630A
$I_n = 80A$	800A
$I_n = 100A$	1000A
Line voltage connection	Arbitrary above or below

Installation Parameters

Degree of protection (IP)	IP20, IP40 (when fitted)
Operating ambient temperature	-25°C ~+70°C
Terminal connection type	Cable/Busbar
Connectable conductor cross section	1-35mm ²
Mounting	IEC/EN 60715 top-hat rail 35mm
Fastening torque of terminals	2-3.5N.m
Pollution degree	2
Altitude	≤ 2000m
Relative humidity	≤ 95%
Resistance to humidity and heat	Class 2
Installation class	III

Technical Data

Dimensions

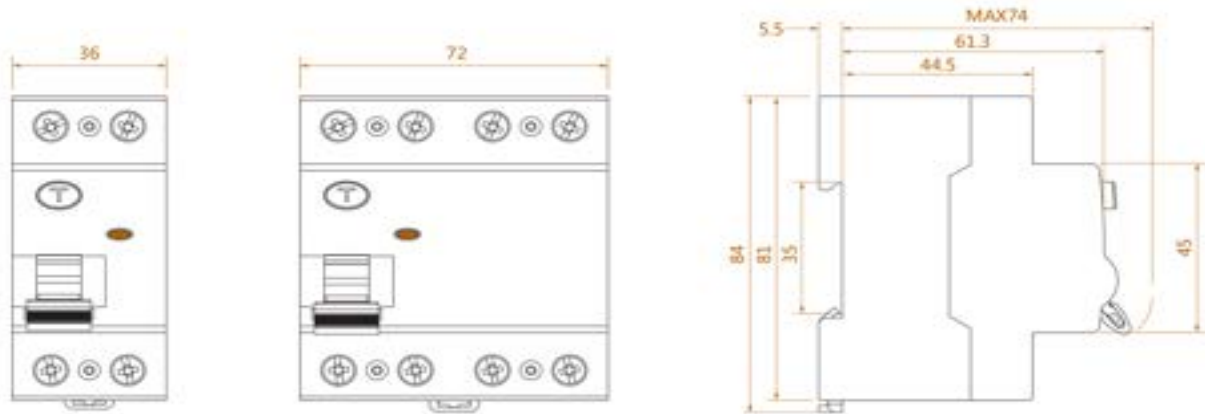

Wiring Diagrams



Tripping Characteristics

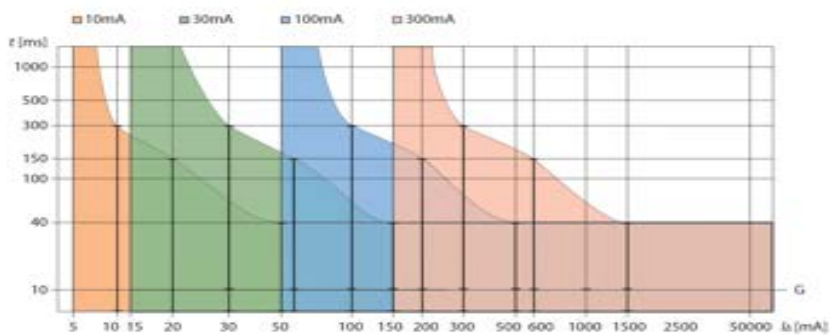

Technical Data

Tripping Characteristics

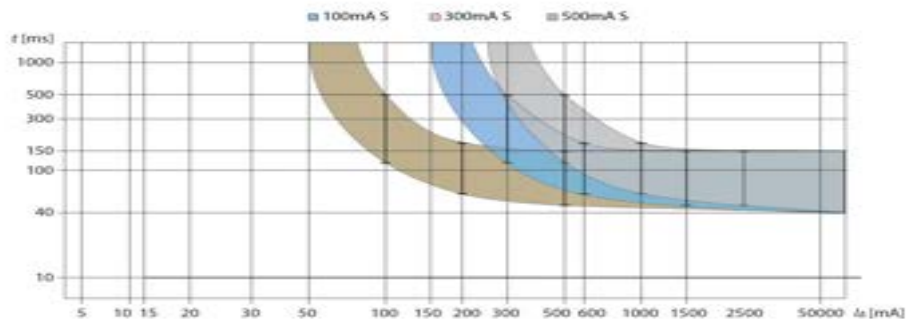

Power Loss

I_n	I_Δ	1P + N	3P + N
25A	10mA	3.4W	7.2W
	30mA	3.4W	7.2W
	100mA	3.4W	7.2W
	300mA	3.4W	7.2W
	500mA	3.4W	7.2W
40A	30mA	7.2W	15.3W
	100mA	7.2W	15.3W
	300mA	7.2W	15.3W
	500mA	7.2W	15.3W
63A	30mA	15W	24W
	100mA	15W	24W
	300mA	15W	24W
	500mA	15W	24W

Interruttore Differenziale Puro (RCCB)

Interruttore Differenziale Puro conforme alla norma IEC/EN 61008-1

Tipo elettromagnetico

Condizione di corrente nominale di cortocircuito I_{nc} 6kA

Versioni 1P + N e 3P+N

Corrente differenziale nominale 10, 30, 100, 300mA

Corrente Nominale fino a 63A

Voltaggio Nominale 230/400V AC

Tipi AC e A



PR8NM Interruttore Differenziale Puro (RCCB) è un dispositivo di sicurezza che interrompe rapidamente un circuito elettrico per proteggere gli apparecchi, progettato per scollegare i cavi conduttori ("scattare") abbastanza velocemente da prevenire potenzialmente lesioni gravi alle persone e danni ai dispositivi elettrici.

È comunemente utilizzato in applicazioni domestiche, commerciali e industriali.

Struttura dello SKU



SKU	Categoria	Tipologia	Poli/Moduli	Interruzione	Corrente Nominale
GC15325	RCCB	Tipo A	1P + N, 2M	6000A	25A
GC15340	RCCB	Tipo A	1P + N, 2M	6000A	40A
GC15363	RCCB	Tipo A	1P + N, 2M	6000A	63A
GC15625	RCCB	Tipo A	1P + N, 2M	6000A	25A
GC15640	RCCB	Tipo A	1P + N, 2M	6000A	40A
GC15663	RCCB	Tipo A	1P + N, 2M	6000A	63A
GC16363	RCCB	Tipo A	3P + N, 4M	6000A	63A
GC16663	RCCB	Tipo A	3P + N, 4M	6000A	63A
GC75325	RCCB	Tipo AC	1P + N, 2M	6000A	25A
GC75340	RCCB	Tipo AC	1P + N, 2M	6000A	40A
GC75363	RCCB	Tipo AC	1P + N, 2M	6000A	63A
GC75625	RCCB	Tipo AC	1P + N, 2M	6000A	25A
GC75640	RCCB	Tipo AC	1P + N, 2M	6000A	40A
GC75663	RCCB	Tipo AC	1P + N, 2M	6000A	63A
GC76363	RCCB	Tipo AC	3P + N, 4M	6000A	63A
GC76663	RCCB	Tipo AC	3P + N, 4M	6000A	63A

** Si informa che tutti gli articoli sopra indicati sono disponibili. Su richiesta, è possibile fornire ulteriori varianti o soluzioni personalizzate per soddisfare esigenze specifiche.

Product Tips

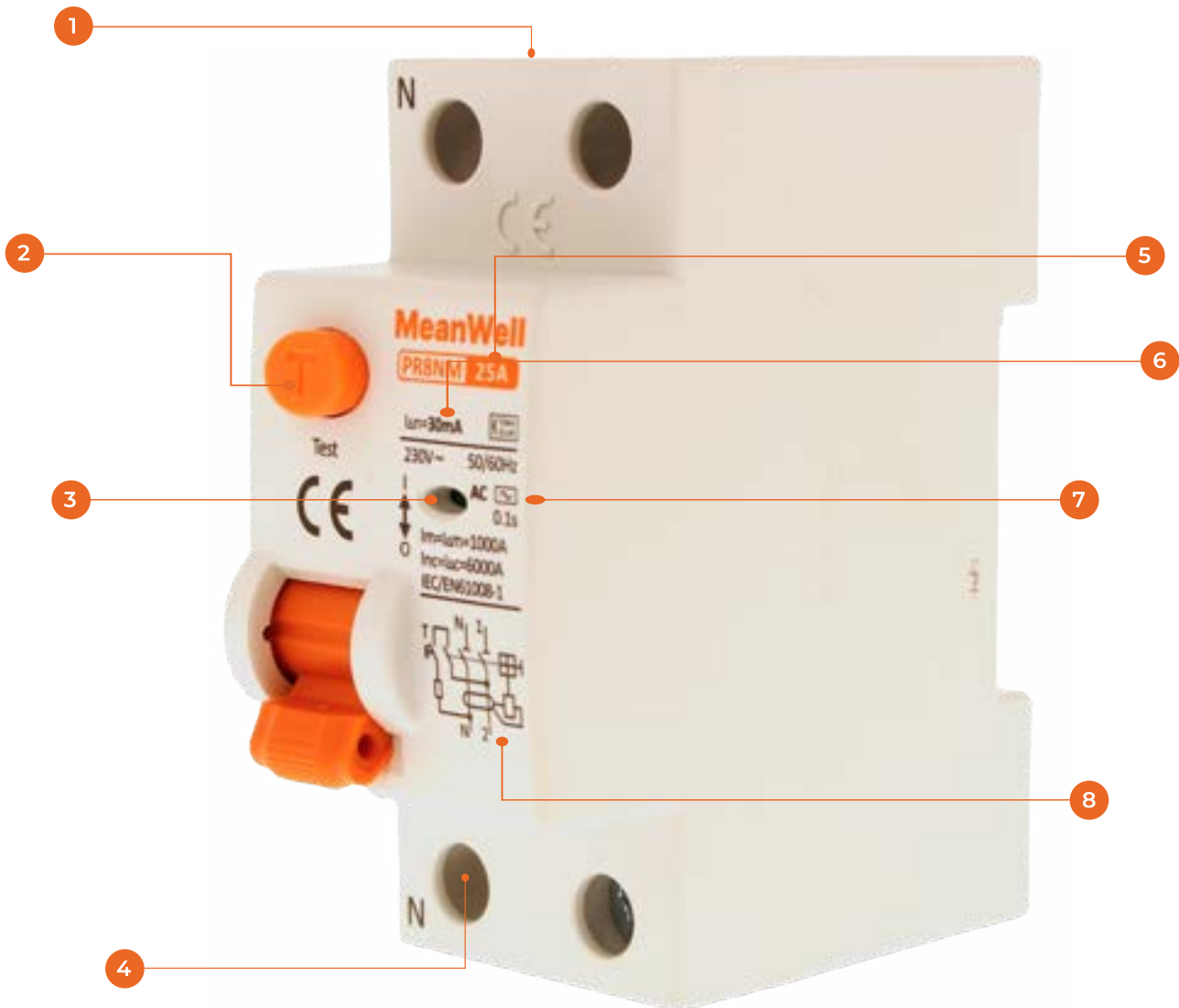

- | | |
|---------------------------------------|--|
| 1 Busbar interface | 5 Rated current up to 63A |
| 2 Test button | 6 Variants from 10 to 300mA $I_{\Delta n}$ available |
| 3 Contacts position indication window | 7 Sensitivity to residual current A |
| 4 Neutral line interface | 8 Electromagnetic circuit diagram |

Technical Data

Electrical Features	
International standard	IEC/EN 61008-1
Poles	1P + N, 3P+N
Rated current	25, 40, 63A
Rated residual current	$I_{\Delta n}$ 10, 30, 100, 300mA
Residual current protection type	Electromagnetic
Conditional short circuit strength	I_{nc} 6kA
Rated operational voltage	U_e 230/400V AC
Min. voltage for RCD function	Independent of voltage
Voltage range of the test button T	150 - 253V AC (1P + N) / 150 - 440V AC (3P + N)
Sensitivity to residual current	AC type - AC Residual current A type - residual AC and pulsating DC current
Time characteristic	AC, A - Undelayed type
Rated frequency	50/60Hz
Rated insulated voltage	U_i 500V AC
Rated impulse withstand voltage	U_{imp} 6kV
Dielectric test voltage	2.5kV
Mechanical service life	10000 operation cycles
Electrical service life	4000 operation cycles
Back up fuse for overload	
$I_n = 25A$	max, 25AgG
$I_n = 40A$	max, 32AgG
$I_n = 63A$	max, 50AgG
Back up fuse for short circuit	
$I_n = 25A$	max, 63AgG
$I_n = 40A$	max, 63AgG
$I_n = 63A$	max, 63AgG

Technical Data

Electrical Features

Rated residual making and breaking capacity $I_m / I_{\Delta m}$	
$I_n = 25A$	500A
$I_n = 40A$	500A
$I_n = 63A$	630A
Line voltage connection	Arbitrary above or below

Installation Parameters

Degree of protection (IP)	IP20, IP40 (when fitted)
Operating ambient temperature	-25°C ~+70°C
Terminal connection type	Cable/Busbar
Connectable conductor cross section	1-25mm ²
Mounting	IEC/EN 60715 top-hat rail 35mm
Fastening torque of terminals	2-3.0N.m
Pollution degree	2
Altitude	≤ 2000m
Relative humidity	≤ 95%
Resistance to humidity and heat	Class 2
Installation class	III

Tripping Characteristics

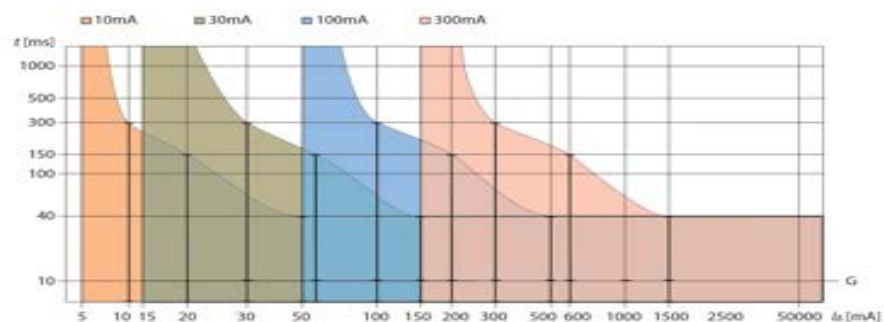

Technical Data

Dimensions

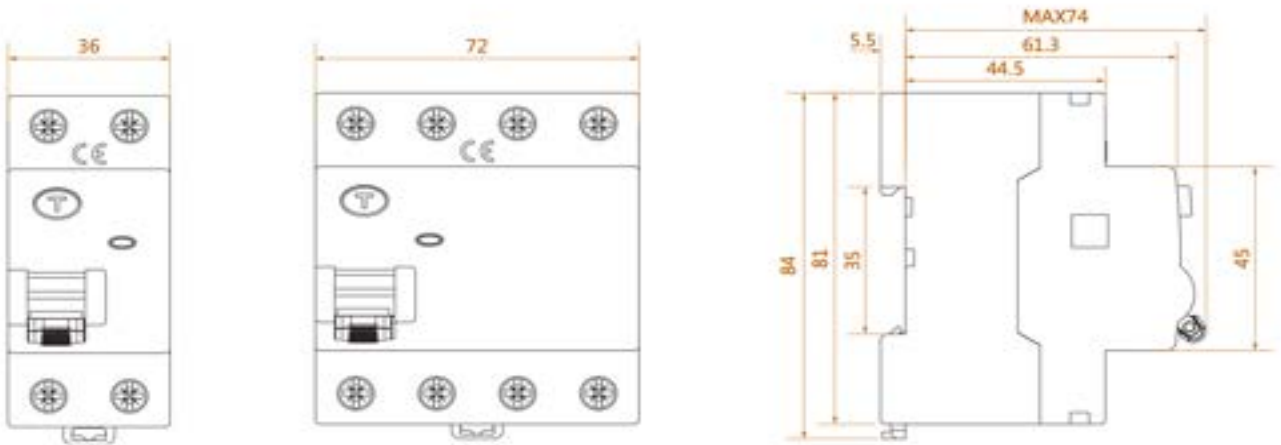

Wiring Diagrams



Power Loss

I_n	I_Δ	1P + N	3P + N
25A	10mA	3.4W	7.2W
	30mA	3.4W	7.2W
	100mA	3.4W	7.2W
	300mA	3.4W	7.2W
40A	30mA	7.2W	15.3W
	100mA	7.2W	15.3W
	300mA	7.2W	15.3W
63A	30mA	15W	24W
	100mA	15W	24W
	300mA	15W	24W

Interruttore Sezionatore Modulare

Interruttore Sezionatore Modulare

Corrente nominale di tenuta al cortocircuito
 $I_{cw} = 12 \times I_n$

Versioni da 1 a 4 poli

Corrente Nominale fino a 125A

Voltaggio Nominale 230/400V AC

Può essere collegato tramite barre collettive standard con tipo a forcella o tipo a spina.



L'Interruttore sezionatore modulare viene utilizzato per garantire che un circuito elettrico sia completamente de-energizzato per interventi di servizio o manutenzione. Viene impiegato esclusivamente per interrompere il circuito e si trova spesso in applicazioni di distribuzione elettrica e industriale, dove è necessario rimuovere la fonte di alimentazione di un macchinario per effettuare regolazioni o riparazioni.

Struttura dello SKU



SKU	Categoria	Tipologia	Poli/Moduli	Interruzione	Corrente Nominale
GD02025	DH	N/A	2P, 2M	N/A	25A
GD02040	DH	N/A	2P, 2M	N/A	40A
GD02063	DH	N/A	2P, 2M	N/A	63A
GD02125	DH	N/A	2P, 2M	N/A	125A
GD04063	DH	N/A	4P, 4M	N/A	63A
GD04125	DH	N/A	4P, 4M	N/A	125A

** Si informa che tutti gli articoli sopra indicati sono disponibili. Su richiesta, è possibile fornire ulteriori varianti o soluzioni personalizzate per soddisfare esigenze specifiche.

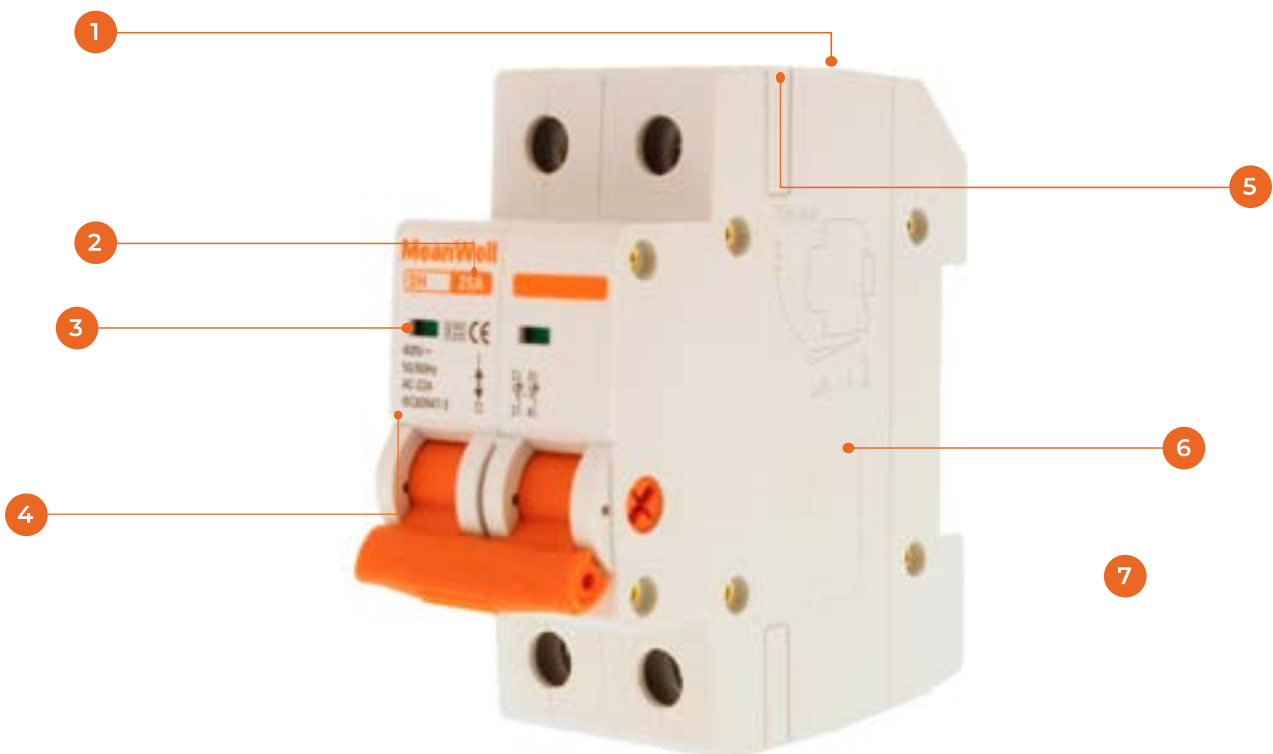

- 1 Reversible line and load connection
- 2 Rated current up to 125A
- 3 Contacts position indication window
- 4 International standards
- 5 Busbar interface
- 6 Modifiable modules for ODM clients
- 7 The position of handle lock

Technical Data

Electrical Features		
International standard		IEC/EN 60947-3
Poles		1P, 2P, 3P, 4P
Rated current		63-125A
Utilization category		AC-22A
Rated operational voltage	U_e	230/400V AC
Rated frequency		50/60Hz
Rated insulated voltage	U_i	500V AC
Rated impulse withstand voltage	U_{imp}	6kV
Rated short-time withstand current	$I_{cw, 1s}$	12 I_e
Rated short-time making capacity I_{cm}	$I_n=63A$	1260A
	$I_n=80, 100, 125A$	2500A
Mechanical service life		10000 operation cycles
Electrical service life		4000 operation cycles

Installation Parameters	
Degree of protection (IP)	IP20, IP40 (when fitted)
Operating ambient temperature	-25°C ~+70°C
Terminal connection type	Cable/Busbar
Connectable conductor cross section	16-50mm ²
Mounting	IEC/EN 60715 top-hat rail 35mm
Fastening torque of terminals	2-3.5N.m
Pollution degree	2
Altitude	≤ 2000m
Relative humidity	≤ 95%
Resistance to humidity and heat	Class 2
Installation class	III

Technical Data

Combination with Accessories

Auxiliary contact	NO
Alarm contact	NO
Shunt release	NO
Shunt release + Aux	NO
Undervoltage release	NO
Overvoltage release	NO
Over & under voltage release	NO

Dimensions

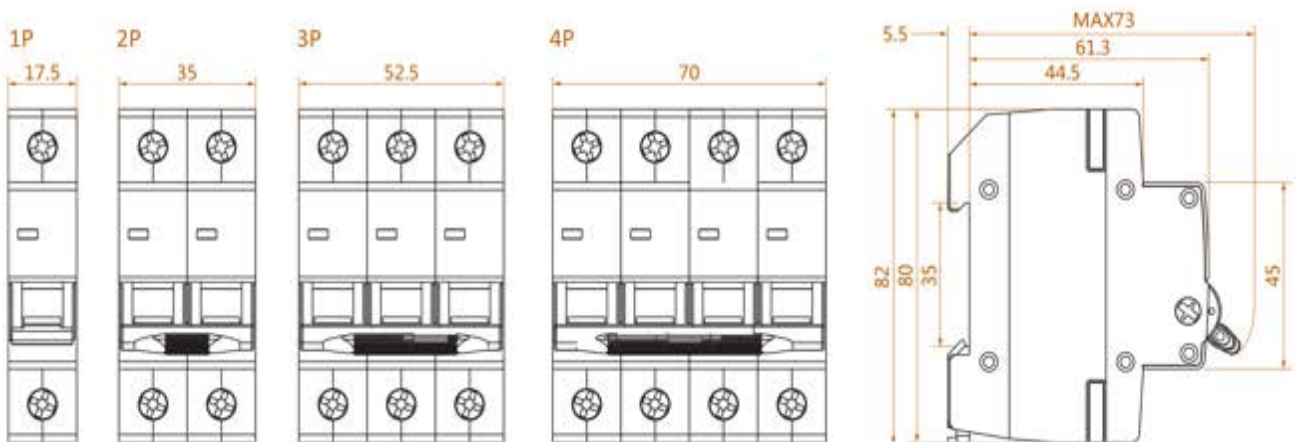

Wiring Diagrams

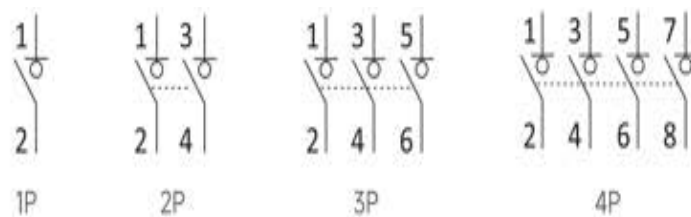

Scaricatore Di Sovratensione (SPD)

Tipo 1+2 (Classe I+II, T1+T2, B+C)

Scaricatore di sovratensione conforme alla norma EN 61643-11

Corrente di impulso max I_{imp} : 8 kA e 12,5 kA per modulo e 50 kA per il modulo NPE

Tensione operativa continua massima U_c da 275 V a 440 V AC

Versioni da 1 a 4 poli

Design del modulo a innesto

Con e senza contatto di indicazione remota

Indicatore di stato del dispositivo



Gli scaricatori di sovratensione sono progettati per proteggere da colpi di fulmine indiretti e diretti a bassa intensità. Nella rete trifase TN-C standard, forniscono protezione per i requisiti LPL III, IV indicati nella norma EN 62305, con una corrente totale di fulmine introdotta nell'impianto elettrico di 37,5 kA e una corrente totale di scarica di fulmine di 75 o 100 kA, in base alla configurazione fisica e alla posizione reciproca del punto di messa a terra del parafulmine, del punto di messa a terra dell'impianto elettrico e del luogo di installazione del dispositivo SPD.

Struttura dello SKU



SKU	Categoria	Tipologia	Poli/Moduli	Interruzione	Corrente Nominale
GF45251	SPD	Tipo 1+2 T1+T2 B+C	1P + N, 2M	N/A	N/A
GF46251	SPD	Tipo 1+2 T1+T2 B+C	3P + N, 4M	N/A	N/A

** Si informa che tutti gli articoli sopra indicati sono disponibili. Su richiesta, è possibile fornire ulteriori varianti o soluzioni personalizzate per soddisfare esigenze specifiche.

Scaricatore Di Sovratensione (SPD)

Tipo 2 (Classe II, T2, C)

Scaricatore di sovratensione conforme alla norma EN 61643-11

Corrente nominale di scarica I_n : 20 kA per modulo e 40 kA per il modulo NPE

Tensione operativa continua massima U_c da 275 V a 440 V AC

Versioni da 1 a 4 poli

Design del modulo a innesto

Con e senza contatto di indicazione remota

Indicatore di stato del dispositivo



Gli scaricatori di sovratensione sono progettati per proteggere da sovratensioni transitorie causate da operazioni di commutazione rapida o da colpi indiretti di fulmine (effetti residui).

Si raccomanda di installare SPD di Classe II ogni 10-20 metri di lunghezza del cavo in modo ripetitivo, tipicamente nei quadri di distribuzione principali e secondari. I modelli N8UE2 20 440 sono progettati per una coordinazione diretta con SPD di Classe I della linea Ex9UE1 35. Nel caso della linea N8UE2 20 440, la coordinazione con la linea N8UE1+2 B35 avviene tramite una lunghezza del cavo di 10 m.

Struttura dello SKU



SKU	Categoria	Tipologia	Poli/Moduli	Interruzione	Corrente Nominale
GF25200	SPD	Tipo 2 T2	1P + N, 2M	N/A	N/A
GF26200	SPD	Tipo 2 T2	3P + N, 4M	N/A	N/A
GF27200	SPD	Tipo 2 T2	1P + N, 2M	N/A	N/A
GF57050	SPD	Tipo 2+3 T2+T3	1P + 1P, 1M	N/A	N/A

** Si informa che tutti gli articoli sopra indicati sono disponibili. Su richiesta, è possibile fornire ulteriori varianti o soluzioni personalizzate per soddisfare esigenze specifiche.

Contattore Modulare (AC)

Contattore modulare conforme alla norma IEC/EN 61095

Corrente nominale fino a 25A, 40A, 63A, 100A

Tensione operativa continua massima U_c fino a 500 V

Versioni da 1 a 4 poli

Tensione di esercizio nominale: 230 V AC



I contattori sono apparecchi di controllo modulare con una struttura innovativa e di piccolo volume. Le loro caratteristiche includono l'installazione su guida DIN, dimensioni modulari, design elegante e sicurezza. Possono essere combinati con interruttori magnetotermici per applicazioni in quadri di illuminazione. Utilizzano materiali isolanti di alta qualità che migliorano l'indice di sicurezza. Hanno un aspetto gradevole, bassa rumorosità e sono adatti per hotel, ospedali e altri ambienti simili.

Struttura dello SKU



SKU	Categoria	Tipologia	Poli/Moduli	Interruzione	Corrente Nominale
GH21125	AC	N/A	2P, 1M	N/A	25A
GH21225	AC	N/A	2P, 1M	N/A	25A

** Si informa che tutti gli articoli sopra indicati sono disponibili. Su richiesta, è possibile fornire ulteriori varianti o soluzioni personalizzate per soddisfare esigenze specifiche.